

SECTION 3

Project Description

3.1 Project Overview

West Basin’s proposed Ocean Water Desalination Project (Project) would produce 20 million gallons per day (MGD) of potable water supply (Local Project), with potential expansion to up to 60 MGD (Regional Project). The Local Project would provide approximately 11 percent of West Basin’s water demand, relieving pressure on the heavily constrained supply of imported water. The new water source would increase the overall water supply reliability, drought resiliency, and water security in the region. The Local Project would be used to serve communities within West Basin’s service area. The Regional Project would be initiated by West Basin in partnership with other local and regional partners, such as Metropolitan Water District of Southern California (MWD), to meet the demands and increase water supply reliability for a larger portion of the Southern California community. This Project Description describes the Local Project (20 MGD) at a “project level,” pursuant to CEQA Guidelines Section 15161, and the Regional Project (60 MGD) at a “program level,” pursuant to CEQA Guidelines Section 15168, assuming implementation of the Local Project has already occurred.¹ The Ocean Water Desalination Project consists of:

- A new **ocean water desalination facility** consisting of a pretreatment system and a reverse osmosis (RO) system to be constructed at the existing El Segundo Generating Station (ESGS) site that would produce 20 MGD (expandable to 60 MGD) of potable drinking water.
- An **ocean water intake system and brine discharge system** consisting of repurposing and upgrading existing offshore intake and discharge tunnels that would deliver raw ocean water to the desalination facility and discharge concentrated seawater back to the ocean.
- A **desalinated water conveyance system** to be constructed inland of the ESGS to deliver potable water produced at the new desalination facility to the local and regional water supply systems.

These proposed facilities are described in detail below. Since these are preliminary designs based on current conditions, the details may change as the designs become finalized.

¹ Because some of the Regional Project’s specific details have not yet been determined, the Regional Project is evaluated at a programmatic level. However, where available, this EIR includes substantial detailed descriptions and analyses, and sufficiently conservative assumptions (as described in Section 3.2 and each impact section) such that the Regional Project’s environmental impact analysis should minimize the scope of any further CEQA review of the Regional Project.

3.2 Project Location

The new ocean water desalination facility would be constructed at the existing 33-acre ESGS site, an industrial property located on the Santa Monica Bay coast at 301 Vista del Mar, El Segundo, California. The ESGS property is located in the South Bay region of Los Angeles County within West Basin's service area, just south of Los Angeles International Airport (LAX), as shown in **Figure 3-1**. West Basin provides potable water to 9 retailers (including investor-owned utilities as well as City and County Water Departments) that service 17 cities in southern Los Angeles County in the area shown in **Figure 3-2**.

Surrounding land uses include Santa Monica Bay to the west, Vista del Mar and the Chevron El Segundo Oil Refinery to the east, the Chevron Marine Terminal to the north, and 45th Street and the city of Manhattan Beach to the south. Other notable nearby land uses include the Los Angeles Department of Water and Power's Scattergood Generating Station located approximately 0.25 miles north, the City of Los Angeles-owned Hyperion Water Reclamation Plant located 0.5 miles north, and LAX located approximately 2.5 miles north. Recreational areas adjacent to the Project include the Marvin Braude Bike Trail and public beaches to the west.

Access to the ESGS is provided via Vista del Mar and a private gated access road located approximately 750 feet north of 45th Street. Existing ground elevations at the site slope from east to west from 90 feet to 20 feet above mean sea level.

Within the ESGS facility there are two potential locations for the proposed Project: one located at the northern portion of the ESGS site (North Site), and the other at the southern portion (South Site). The South Site is an approximate 13-acre area that was the previous site for two large above-ground fuel oil tanks, which were removed in 2013. The ESGS North Site is an approximate 8-acre area located in the middle of the ESGS property, which was the previous site for two NRG Energy (NRG) conventional steam turbine units (Units 3 and 4) that were decommissioned (December 2015) but are still existing on-site. These existing power generating stations would need to be demolished prior to constructing the Project on the North Site.

Figure 3-3 shows the locations of the two proposed site alternatives within the ESGS property.

The ocean water intake and concentrate discharge tunnels proposed for utilization were installed in 1965 to supply cooling water to the power generating stations that have occupied the ESGS site. **Figure 3-4** shows the location of the existing offshore tunnels.

Potable water produced at the facility would be conveyed to the existing local water distribution system through a new conveyance system. The new conveyance system would connect to the local distribution system serving the cities of El Segundo, Redondo Beach, Lawndale, Gardena, and Hawthorne and portions of unincorporated Los Angeles County. Proposed distribution pipelines alignments and pump station locations are shown in **Figure 3-5**. A schematic concept of the entire desalination process is included in **Figure 3-6**.

3.3 Project Objectives

West Basin's goal is to guarantee future water supply reliability for service area customers by adding a locally produced, drought-proof potable water source to the West Basin supply portfolio, consistent with goals for desalinated ocean water supplies identified in West Basin's 2015 Urban Water Management Plan. The need for water supply reliability has been highlighted by increased frequency and prolonged duration of recent droughts and decreasing reliability of imported water supplies.

The Project objectives of West Basin's proposed Ocean Water Desalination Project are to:

- Diversify West Basin's water source portfolio to increase reliability in the near and intermediate term (5–15 years) and the long term (15–30 years) while reducing reliance on imported water.
- Improve water security through West Basin's increased local control of water supplies and infrastructure.
- Improve West Basin's local control of future water costs and long-term price stability.
- Improve climate resiliency by developing a water source that is less susceptible to hydrologic variability.
- Develop a potable water supply that is economically viable and environmentally responsible.

3.4 Project Components

3.4.1 Local Project

Ocean Water Desalination Facility

The proposed desalination facility would consist of multiple buildings and structures supporting the desalination process. The basic components would include an intake pump station, a pretreatment system to remove large particles and suspended solids, an RO desalination treatment to remove dissolved salt from the seawater, post-treatment water conditioning facilities, final product water storage (referred to as a clearwell), desalinated water pump station, and brine discharge pump station. **Figure 3-7** and **Figure 3-8** provide process flow charts for the Local Project. Residuals handling and disposal facilities would be needed to accommodate backwash water and solids from the treatment and membrane cleaning processes. In addition, appurtenant facilities, for storing and handling chemicals and for generating and/or receiving and distributing power, and an Administration/Operations Building would be required. A new access road would be constructed to provide access from the north. **Table 3-1** lists primary components of the treatment facility.

Figure 3-9 and **Figure 3-10** show the two possible desalination facility layouts that could be used for the Local Project at the ESGS South Site and ESGS North Site. The Local Project would require 45 MGD of ocean water to meet the 20 MGD product water volume. The tallest building would be approximately 40 feet from the existing ground elevation for ESGS South Site and

65 feet for the ESGS North Site. **Figures 3-11** through **3-14** illustrate approximate building heights and ground elevations.

TABLE 3-1
LOCAL PROJECT DESALINATION FACILITY UNIT PROCESS / BUILDING FOOTPRINT AT ESGS SOUTH SITE AND NORTH SITE

Facility	South ESGS Site Footprint (SF)	North ESGS Site Footprint (SF)
Intake/Discharge Vault	2,450	2,450
Intake Pump Station	3,150	3,150
Pre-Treatment Option: High-Rate Granular Media Filters	NA ¹	NA ¹
Pre-Treatment Option: HRGMF Filtrate Storage Basin	12,150	12,800
Pre-Treatment Option: Membrane Filtration	13,770	13,770
Pre-Treatment Option: MF Filtrate Storage Basin	13,770	13,770
Pre-Treatment Option: MF Filtrate Channel	1,500	1,500
Reverse Osmosis	NA ¹	NA ¹
Permeate Tank	3,600	3,600
Calcite Contactors	12,750	9,500
Chemical Handling & Residuals Management	NA ¹	NA ¹
Product Water Storage Basin	20,300	20,300
Desalinated Water Pump Station)	5,000	4,200
Surge Tanks	3,850	3,850
Waste Backwash Water Equalization	9,900	9,450
WBW Treatment (Clarifier)	4,125	4,900
Treated WBW Storage	4,125	4,550
Discharge Storage Basin	1,200	3,000
Discharge Pump Station	NA	3,500
Electrical Substation Phase 1	11,340	10,500
Joint Administration/Operations	15,000	15,000

NOTES:

¹ Located above or beneath other facilities.

Intake Pump Station

Ocean water would be pumped from the existing ESGS tunnel via a system of onshore pipelines and an intake pump station. The intake tunnel enters a belowground rectangular intake vault near end of the tunnel within the ESGS site. Vertical intake pumps, drawing water directly from the wet well, would pump the water into the intake pipeline system. For the Local Project, this intake pump station would have a pumping capacity of 42 to 45 MGD (depending on the ultimate process design), and a combined horsepower (HP) of approximately 750 HP (for a desalination facility at the ESGS North Site) to 950 HP (for a desalination facility at the ESGS South Site), plus appropriate standby capacity. For the ESGS South Site, the ocean feedwater would be

conveyed directly to pretreatment system facilities via one or two parallel buried high-density polyethylene (HDPE) pipelines 2,100 feet in length parallel to and inland of the bike path. For the ESGS North Site, feedwater would be pumped directly into adjacent pretreatment facilities.

Pretreatment Facilities

Ocean water received from the intake system would be delivered to pretreatment facilities that consist of either high-rate granular media filtration followed by membrane filtration (HRGMF/MF) or granular media filtration (GMF). The HRGMF/MF preliminary treatment process (Figure 3-7) was pilot-tested by West Basin and produced effective and efficient pretreatment for the downstream MF processes; while the alternative GMF approach (without the MF treatment process; Figure 3-8) has been used with success in other large-scale desalination facilities, such as the Claude “Bud” Lewis Carlsbad Desalination Plant in San Diego County, California. Both employ periodic backwashing, using filtrate, and result in a waste stream that is 1 to 3 percent of the filtered flow. Initial mechanical screens or HRGMF would remove large suspended particles and algae larger than 100 microns. Low dosages of ferric-based coagulant (3 to 5 mg/L) may be dosed in the feedwater in response to raw water quality issues such as algal bloom events. Backwash water may be recovered back to the head of the pretreatment process to operate at essentially 100 percent recovery or may be discharged to the ocean through the discharge facility.

In the case of the HRGMF/MF approach (Figure 3-7), the HRGMF filtrate would be conveyed through the additional MF pretreatment. The MF pretreatment system would consist of a number of discrete process units housing hollow fiber membrane modules, valve manifolds, and connecting piping to direct the flow of feed, filtrate, cleaning solutions, backwash supply, backwash waste, and compressed air.

Accumulated solids would be removed from the MF membranes through the backwashing process, which is required to keep the membranes functioning properly. It may become necessary to routinely add hypochlorite to the backwash if there is an increase in organic or biological fouling to the membranes. This process would generate a backwash that would contain chlorine residuals requiring dechlorination. Other chemicals that may be used for cleaning MF systems typically include citric acid and caustic soda. All waste chemical cleaning solutions from the MF cleaning process would be collected in a holding tank. From there, the waste solutions would be pumped to a chemical waste neutralization system for treatment and disposal (see *Residuals Handling and Disposal*).

As an alternative to the HRGMF/MF pretreatment process, a GMF pretreatment system (Figure 3-8) may be employed. GMF pretreatment would replace the HRGMF/MF membranes with granular media filters consisting of deep bed gravity granular media filters arranged around a pipe gallery that would contain feed piping and valves, backwash, and surface wash piping and valves, filter control valves and compressed air piping and valves. The backwashing process would occur approximately once per day, resulting in a backwash stream that is approximately 3 percent of the filtered flow.

Reverse Osmosis Treatment Process

Desalination would be accomplished using RO, a process which pushes water through semi-permeable membranes to remove dissolved salts, producing a purified permeate stream and a concentrated brine stream. The proposed process would include a first-pass RO membrane system treating the pretreated ocean water supply, and a second-pass system treating a portion² of the product water from the first-pass system. Recovery in each RO pass (the amount of permeate extracted per gallon of feedwater) is expected to be 50 percent for the first-pass system and 90 percent for the second-pass system.

The second-pass system is intended to assist in additional removal of monovalent ions, such as boron and chloride. The final product water will meet a target boron concentration of 0.5 mg/L, a bromide concentration level of less than 0.3 mg/L, and a chloride concentration level of less than 100 mg/L. Caustic and antiscalant chemicals (approved for use in potable water treatment facilities) may be added to the second-pass RO feed to allow the treatment process to operate at high recovery without causing scaling issues.

The RO system would include four individual first-pass process trains,³ and two second-pass process trains, with each process train being composed of a, high-pressure pump, membrane elements in 8-inch-diameter pressure vessels mounted on racks (arrays), and connecting piping and valve manifolds for feed, permeate, cleaning, and flush supplies. The first-pass RO process would include energy recovery devices (ERDs). Centralized membrane cleaning systems would serve the multiple trains and a 500,000-gallon permeate storage tank (outside of the RO Building) would be provided for flushing and to provide a source of permeate to the RO system during shut-downs. All RO equipment would be housed in a single large building.

Antiscalant may also be added to the first-pass RO feedwater to protect the RO process membranes. A portion of the permeate water from the first-pass RO would be further processed by the second-pass RO treatment. The second-pass RO process permeate would flow through calcite contactors, then blend with the balance of first-pass permeate. Approximately 24 percent of the final product would receive second-pass treatment, on average. Concentrate from the RO system would be permitted for discharge to the existing ESGS discharge tunnel.

Similar to MF membranes, RO membranes are periodically cleaned with chemicals every 4 to 12 months. Alkaline solutions would be used periodically to remove silt deposits and biofilms from membranes, while acidic solutions would be applied to dissolve metal oxides or scales. Cleaning solutions often contain additional chemicals to improve membrane cleaning, including alkaline detergents (e.g., dodecyl sulfate, dodecyl sulfonate, which are approved for use in potable water treatment systems).

All RO chemical systems would be housed within the RO Building. All waste chemical cleaning solutions would be collected in a holding tank. From the holding tank, the waste solutions would

² On an annual average, approximately 24 percent of the total product would come from the second pass. During warm summer months, approximately 40 percent of the total product water would be from the second-pass RO.

³ “Train” is industry terminology for one of two or more complete RO installations, including membranes and high-pressure pump operating in parallel.

be transferred to the chemical waste neutralization system in the Chemical/Residuals Handling Building and then pumped to one of the potential sanitary sewer systems.

Post-Treatment of Permeate

Following the Second-Pass RO system, permeate water would flow to calcite contactors for stabilization, and then be blended with the first-pass RO permeate bypass stream. Subsequently, post-treatment includes pH adjustment and disinfection with sufficient contact time to meet pathogen destruction and inactivation requirements of the California Division of Drinking Water pursuant to federal drinking water regulations.

Post-treatment would add calcium and alkalinity into the permeate water by first adding carbon dioxide to the permeate, and then allowing it to flow through a calcite contactor before adding caustic soda. The post-treatment process would be assessed during final design and implementation to ensure proper dosage selection and operational control for the proposed facility.

Following stabilization, the pH of the water would be adjusted through the addition of sodium hydroxide (caustic soda). Sodium hypochlorite and ammonia would be used to produce chloramine for disinfection purposes. Chloramine would be added ahead of the product water storage tank for disinfection at a dosage rate necessary to achieve pathogen inactivation and destruction. For the Local Project, the product water storage tank has been sized for 3.4 million gallons (MG) to provide 4 hours of contact time plus approximately 0.4 MG of operational storage for a total of 3.8 MG. The 4 hours of contact time is provided to achieve the aforementioned disinfection. At the outlet of the tank, but prior to distribution, additional chloramine would be added to restore the chloramine residual to targeted levels.

Desalinated Water Storage and Pumping

For the Local Project, the 3.8 MG product water storage tank would be positioned beneath the RO Building and connected to the desalinated water pump station. The desalinated water pump station would pump desalinated water into a new pipeline, which would convey the desalinated water to the distribution system. The desalinated water pump station would use vertical turbine pumps with floor-mounted motors to pump desalinated water into a new pipeline that would convey the desalinated water to the distribution system. For the 20 MGD Local Project, the 22.5 MGD pump station would operate at approximately 2,400 HP (1,700 KW). Surge-control facilities, consisting of one or more hydro-pneumatic tanks, would be required to protect the pump station and pipeline system from hydraulic transients and surges. The surge tanks would be connected to the discharge of the pump station and would be located next to the pump station.

Residuals Handling and Disposal

Residuals handling facilities would include waste backwash treatment, solids handling, and chemical waste neutralization systems.

Waste Backwash Treatment

The waste washwater from initial screening and pretreatment backwashes would flow by gravity to an equalization basin located beneath the Chemical/Residuals Handling Building. From this

basin, flow would be pumped at a constant rate to a clarifier equipped with settling plates for solids removal. Ferric chloride (coagulant) is added in the waste washwater treatment. The clarified effluent would either be pumped to the head end of the plant (i.e., waste washwater recycling) or be permitted for pumping to the discharge pipeline where it would mix with RO brine and be discharged to the existing ESGS discharge tunnel.

Solids Handling and Treatment

The solids removed in the backwash water process would be pumped to centrifuges for dewatering. A polymer may be used in the centrifuge process. The centrifuge facilities would be located in the Chemical/Residuals Handling Building. The dewatered solids would be collected and hauled for disposal or beneficial reuse where possible. Generation of centrifuge cake solids would vary according to seasonal ocean water quality variations, but is expected to be in the range of 0.05 to 0.2 cubic yards (CY) per million gallons of desalinated water produced.

Chemical Waste Neutralization

Membrane cleaning operations would produce approximately 500,000 gallons per year of waste stream for the Local Project. The waste stream would be captured in on-site holding tanks and neutralized and then pumped to the existing sanitary sewer system, which would be to either city of El Segundo or city of Manhattan Beach local sanitary sewer lines.

Chemical Storage and Handling

Chemicals required for the treatment process would be stored on-site and used for control of biological fouling, pretreatment, membrane cleaning, and post-treatment. These chemicals typically include:

- Sodium hypochlorite, which may be used periodically to shock-chlorinate the intake piping system and would be used in the chemical enhanced backwash (CEB) for the MF process, and in the calcite backwash stream.
- Sodium bisulfite, which would be added at the intake pump station to neutralize the chlorine residual that remains after shock chlorination, and for neutralizing chlorine in the spent CEB and calcite backwash.
- Ferric-based coagulant, which would be added routinely during the flocculation process as part of the GMF pretreatment train, or intermittently to the HRGMF and MF processes.
- Citric acid and other proprietary chemicals (approved for use in potable water treatment facilities), for membrane cleaning operations.
- Carbon dioxide and calcite, for post-treatment.
- Ammonia (aqueous form) and sodium hypochlorite, to preform chloramine for pretreatment (optional) and disinfection.
- Caustic soda (sodium hydroxide) for pH adjustment of the second-pass RO feed water and desalinated water.
- Proprietary antiscalant chemicals (approved for use in potable water treatment facilities) for the RO process.
- Polymer (i.e., binding agent) for the centrifuge process (filter backwash solids).

Table 3-2 lists the chemicals, their application, dosages, and annual usage for the Local Project. Bulk chemicals would be stored in gaseous form (carbon dioxide), solid form (calcite), and liquid form (all other chemicals.) All chemicals would be safely stored in bulk on-site in the Chemical/Residuals Handling Building or the Pretreatment Building and RO Building. The bulk storage systems would be designed to provide 10 to 20 days of storage at average dosage rates. The bulk storage would vary according to chemical, and would include small drums and totes (less than 200 gallons), fixed tanks and bins (1,000–15,000 gallons each), and mobile (trailer-mounted) horizontal tanks (up to 7,500 gallons each). Each bulk liquid chemical storage area would be equipped with a separate chemical spill containment area for each chemical capable of containing 110 percent of the maximum amount of that liquid chemical stored on-site. Chemical transportation, storage, and use would comply with state and federal requirements.

**TABLE 3-2
DESALINATION FACILITY CHEMICALS**

Chemical	Purpose	Local Project Storage Capacity (gallons)	Regional Project Storage Capacity (gallons)
Sodium Hypochlorite	Intake Shock Chlorination	11,000	33,000
Sodium Bisulfite	Dechlorination of shock chlorination	4,000	12,000
Sodium Hypochlorite	Preformed Chloramine for bio-control	294,000	882,000
Aqueous Ammonia	Preformed Chloramine for bio-control	53,000	159,000
Ferric Chloride	Pretreatment	118,000	354,000
Sodium Bisulfite	Dechlorination of MF Filtrate	8,000	24,000
Antiscalant	First-Pass RO	33,000	99,000
Antiscalant	Second-Pass RO	2,000	6,000
Sodium Hydroxide	Second-Pass RO	48,000	144,000
Ferric Chloride	Waste Backwash Treatment	12,000	36,000
Polymer	Waste Backwash Treatment - Centrifuge	30	90
Sodium Bisulfite	Concentrate Discharge	60,000	180,000
Carbon Dioxide (gas)	Post-Treatment	-	-
Calcite (solid)	Post-Treatment	-	-
Sodium Hydroxide	Post-Treatment	185,000	555,000
Sodium Hypochlorite	Post-Treatment Disinfection	72,000	216,000
Aqueous Ammonia	Post-Treatment Disinfection	13,000	39,000

Administration/Operations Building

The Administration/Operations Building would be a four-story, 60,000-square-foot facility to accommodate the desalination facility operational and administrative staff. West Basin and NRG would split use of the building. The building would include space for facility administration, visitors, and public water education. It would include a reception area (including public education exhibits), administrative offices, conference room, restrooms, an auditorium with capacity for

approximately 50 persons, lunchroom/kitchen, operations center, lockers, and a maintenance workshop. Parking for this facility would be a single-level parking lot located adjacent to the Administration/Operations Building.

Power Supply and Distribution

Power to the ocean water desalination facility would be provided via overhead power lines directly from Southern California Edison (SCE). Electrical power supply required for the desalination facility, intake pump station, and desalinated water pump station is estimated at 12.4 MW for the Local Project; refer to **Table 3-3**. It is anticipated that the Local Project would require a total annual demand of 105,000 megawatt hours (MWh) per year. An electrical substation would be installed on site to lower the voltage from service voltage to site distribution voltage (Figures 3-9 and 3-10).

**TABLE 3-3
LOCAL PROJECT SUMMARY OF ELECTRICAL POWER SUPPLY SUMMARY (MW)**

Component	Local Project Estimated Power Supply Requirements (MW)
Intake and Pretreatment	0.9
First-Pass Reverse Osmosis ¹	8.3
Second-Pass Reverse Osmosis ¹	0.6
Post-Treatment	0.1
Distribution	1.7
Residuals and Other	0.4
Miscellaneous	0.1
Contingency	0.4
TOTAL	12.5
NOTES: These are preliminary estimates for purposes of CEQA analysis and may be modified during the Project's regulatory permitting, final design, and/or construction process. ¹ Energy consumption is estimated based on the use of existing energy recovery device technology.	

Utility Connections

Utility services for potable water, sewage, communications, and possibly natural gas would use the existing utility service connections at the ESGS North Site. Sanitary sewer connection would be made to either: (1) the existing sewer in Manhattan Beach that connects with the Los Angeles County Sanitation District's Joint Water Pollution Control Plant in Carson that discharges into the Pacific Ocean at Palos Verdes or (2) a connection would be installed to the existing sewer in El Segundo to the north that connects to the City of Los Angeles Hyperion Treatment Plant that discharges into the Santa Monica Bay. More information on utilities within the Project area is included in Section 5.16, *Utilities and Service Systems*.

Screened Ocean Intake and Concentrate Discharge

The proposed Project would intake ocean water and discharge concentrated ocean water via the existing 12-foot-inside-diameter ESGS tunnels (**Figure 3-15**). The tunnels are approximately

23 feet apart on center (approximately 9 to 10 feet apart edge to edge) and are buried 6 to 10 feet below the ocean floor. The northern tunnel is 500 feet longer than the southern tunnel. The tunnels were previously used for cooling water intake and discharge associated with ESGS Units 3 and 4, which have been decommissioned.

The Project would repurpose the northernmost of the two tunnels for the intake. This tunnel extends on a downward slope 2,579 feet from the existing onshore gate structure to a 26-foot by 20-foot vertical concrete intake structure on the ocean floor. The tunnel is equipped with four intermediate access structures (manholes) that extend above the ocean floor. The water depth at the existing intake structure is approximately 28 feet, and the top of the existing intake structure is approximately 15 feet below the water surface. The southern tunnel extends on a downward slope 2,078 feet from the existing onshore gate structure to a 26-foot by 20-foot vertical concrete discharge structure similar to the intake structure. The tunnel is equipped with three intermediate access structures (manholes) that extend above the ocean floor. The water depth at the existing discharge structure is approximately 28 feet and the top of the structure is approximately 20 feet below the water surface.

Ocean Intake Facilities

The existing intake structure is shown in **Figure 3-16a**. The Local Project would involve installation of five new 42-inch pipes inside the existing ESGS intake tunnel to convey ocean water to the desalination facility onshore.⁴ Only two on these pipelines would be used for the Local Project, and the three additional pipelines would be installed for the Regional Project. The existing intake structure would be modified with an extended header pipe connected to 12 new wedgewire screen risers and screens (see **Figure 3-16b**). The tops of the wedgewire screens would be approximately 18 feet below the water surface and approximately 13 feet above the ocean floor.

To install the new intake screens at the terminus of the tunnel, the existing riprap around the concrete risers would be removed. The riprap would be temporarily stockpiled on the ocean floor. If this is infeasible, the riprap would be stockpiled on barges which would then likely be towed to the POLA/POLB to store the riprap in harbor during construction. Dredging of the ocean floor would be required to expose the existing intake structure. A hole would be cut into the structure and the area in front of the structure would be dredged to allow for insertion of the five 42-inch pipes. Once the new pipelines were installed into the 12-foot-diameter tunnel, a new header would be installed at the end of the tunnel and intake risers and wedgewire screens would be attached. The new header would be secured to the ocean floor with new foundation piles. Once the wedgewire screens were attached to the new header, the header would be covered with the previously dredged material. The installation process is depicted in **Figure 3-16c**.

The Local Project would use only four risers and wedgewire screens. The new header would be equipped with additional risers that could accommodate up to 12 wedgewire screens in the future

⁴ Installation of five pipelines within the existing intake tunnel represents the worst-case construction impact scenario given that the conditions of the tunnels are unknown. In the future, if West Basin determines that the conditions of the tunnels are adequate and chooses to use the existing tunnel without internal pipe installation, construction impacts and schedule would be reduced.

if the Regional Project is pursued, eliminating additional disturbance of the seafloor during underwater installation. The proposed intake structure for the Regional Project is depicted in **Figure 3-16d**.

The total intake flow for the Local Project would be 42.2 MGD if the plant uses GMF pretreatment and 45.4 MGD if the plant uses HRGMF/MF pretreatment. Although not required, if treated waste washwater is internally recycled (which would reduce the volume of treated waste washwater), the intake flow could be reduced to approximately 41 MGD.

The openings of the wedgewire screens would not exceed 1 millimeter (mm; or 0.04 inch) and would have a through-screen velocity of less than 0.5 feet per second (fps), consistent with the California Ocean Plan requirements for ocean water desalination facilities. This could be accomplished with up to four wedgewire screens in a cylinder (likely) or plate configuration with a total (combined) net open area of at least 140 square feet. The total gross screen area would be approximately three times the net open area, depending on the design and specified wire size. **Figure 3-17** shows a typical wedgewire screen.



SOURCE: ESA 2018

West Basin Ocean Water Desalination Project/ 170766

Figure 3-17
Typical (Cylindrical) Wedgewire Screen Design

NOTES: The wedgewire screen slot size is smaller than the thickness of a United States penny coin (1.52 millimeters).

To prevent excessive macro-biofouling inside the intake piping system from restricting or blocking water flow, biofouling control such as a shock chlorine solution may be used. If so, the solution would be applied via diffusers in the intake piping system between the screens and the intake pump station. This would require installation of a small-diameter (2-inch) pipe within each of the 12-foot-diameter existing intake tunnel and appropriately placed diffusers to deliver the solution into the intake piping system. The solution would be applied for 2 to 12 hours as often as two times per month. During this routine maintenance procedure, the chlorinated water would be dechlorinated with sodium bisulfite onshore and then go through the normal treatment processes.

Ocean Concentrate Discharge Facilities

The proposed Project would discharge continuous flows of concentrate (brine) from the RO process, and potentially also treated washwater from process washing operations, to the ocean. The existing discharge structure is shown in **Figure 3-18a**. The terminus is approximately 500 feet closer to shore than the intake tunnel. Similar to the intake system, five new 42-inch pipelines

would be installed inside the existing ESGS discharge tunnel (see **Figure 3-18b**).⁵ Only two pipelines would be used for the Local Project, and the three additional pipelines would be used to meet the demands of the Regional Project. Similar to the intake tunnel, to access the terminus of the discharge pipeline, the existing riprap would be cut and then cast aside; while the tunnel exposed through dredging. The area in front of the terminus structure would be dredged to allow for the new pipelines to be inserted into the tunnel.

Once the new pipelines are installed, a multi-port diffuser system consisting of multiple duckbill diffuser ports would be installed directly onto the existing discharge tower. A total of eight duckbill diffuser ports would be installed during construction of the Local Project; however, only four ports would be used for the Local Project (see Section 3.6 below). The remaining four ports would be needed for the Regional Project. The diffuser ports would be positioned 8 feet above the ocean floor and approximately 20 feet below the ocean surface (see **Figure 3-18c**). They would be designed at different angles for lower-velocity discharge in order to substantially reduce turbulence mortality while achieving California Ocean Plan dilution requirements. Once installed, the exposed tunnel would be covered either with the cast-aside dredge material. The installation process is demonstrated in **Figure 3-18d**.

For the 20 MGD Local Project, the normal amount of flow to be discharged from the ocean desalination facility would be approximately 25.4 MGD, which would be composed of approximately 20.9 MGD of RO concentrate (brine) and 4.5 MGD of treated backwash water from the HRGMF and MF processes. If washwater is internally recycled, the normal discharge flow would be reduced to approximately 21 MGD, composed of 20.9 MGD of RO brine and 0.1 MGD from the washwater recycling process (Figure 3-7). If a GMF process is used for pretreatment, and washwater is not internally recycled, the typical total discharge volumetric flow would be approximately 22.2 MGD, composed of 20.9 MGD of brine and 1.3 MGD of treated backwash water from the GMF process. If washwater is internally recycled, the normal discharge flow would be approximately 21 MGD, composed of 20.9 MGD of RO brine and 0.1 MGD from the washwater recycling process (Figure 3.8). Provisions would be included for addition of sodium bisulfite in the concentrate discharge to remove any residual chloramine if/when preformed chloramine addition is in use as a bio-control method in the treatment process.

At times, during startup and infrequently during upsets while the plant is in operation, it may be necessary to bypass the entire treatment facility to discharge. Thus, the discharge system would be sized for a peak discharge from the plant of 41 to 46 MGD.

Onshore Discharge Facilities

For a desalination facility located at the ESGS North Site, a 45 MGD discharge pump station (225 HP) would be required to deliver normal and bypass operation flows and to overcome friction losses in the discharge piping and diffuser nozzles. A desalination facility located at the

⁵ Installation of five pipelines within the existing discharge tunnel represents the worst-case construction impact scenario given that the conditions of the tunnels are unknown. In the future, if West Basin determines that the conditions of the tunnels are good and chooses to use the existing tunnel without internal pipe installation, construction impacts and schedule would be reduced from what is analyzed in this EIR. As a result, this EIR analyzed the worst-case scenario.

ESGS South Site would be located at a higher elevation and the discharge could flow by gravity through the discharge piping to the discharge diffusers.

Desalinated Water Conveyance

New conveyance infrastructure would convey product water from the desalination facility to the existing distribution system that delivers potable water to local area and regional supply feeders owned by MWD. The closest regional potable water feeder system is MWD's West Basin Feeder located within Manhattan Beach Boulevard and the West Coast Feeder located within El Segundo Boulevard. Both of these regional feeders are fed by the MWD Sepulveda Feeder, which is located within the north-south Van Ness Avenue. The locations of existing MWD facilities are shown in Figure 3-5.

Several conveyance alignment alternatives may be used to convey desalinated water from the proposed desalination facility to MWD Feeders System, as shown in Figure 3-5. From the desalination facility, the new pipeline route would head north on Vista del Mar Boulevard, then slightly east on Grand Avenue, and continue east along El Segundo Boulevard to the intersection with Aviation Boulevard. Conveyance option alternative alignments could potentially include parallel alignments continuing along Grand Avenue, along Franklin Avenue, or through Chevron's property (see Figure 3-5). From the intersection of Grand Avenue and Aviation Boulevard, the proposed conveyance pipeline alignment would travel north on Aviation Boulevard to West 120th Street, where it would turn east and connect to the MWD Feeder at Van Ness Avenue. To connect the desalinated water conveyance pipeline to the west end of the existing West Basin Feeder, a pipeline would travel south on Inglewood Avenue from West 120th Street to Manhattan Beach Boulevard. Additionally, pipeline alternative alignments would be routed through various alternative routes to connections along the existing West Basin and West Coast Feeders. The various pipeline conveyance and alternative conveyance routes are shown in Figure 3-5.

3.4.2 Regional Project

The 60 MGD Regional Project would be an expansion of the initial 20 MGD Local Project that may occur in one or two increments (Phases 2 and/or 3). The Regional Project would add incrementally to the already constructed Local Project (see Figures 3-7 and 3-8, which also illustrate a process flow diagram for the Regional Project).

Ocean Water Desalination Facility

Figure 3-19 and **Figure 3-20** show two desalination facility layouts for the ESGS South Site and the ESGS North Site. The majority of the facilities needed to operate the Regional Project would already have been constructed as part of the Local Project, with several modifications required to operate the additional volume. Table 3-1 identifies facility components and square footage of the Regional Project additions.

Pretreatment Facilities

The same pretreatment processes with additional treatment capacity would be required for the Regional Project to support the 60 MGD Regional Project. If MF pretreatment is used, the MF

Buildings for Phase 2 (40 MGD) and Phase 3 (60 MGD) could be constructed in a stacked configuration on the Phase 1 MF Building and MF Filtrate Storage Basin, respectively.

RO Treatment Process

The same pretreatment processes with additional treatment capacity would be required for the Regional Project to support the 60 MGD Regional Project. Each phase of expansion would require an additional set of first-pass RO and second-pass RO treatment equipment and buildings to support the subsequent production expansion of up to 40 MGD and 60 MGD Regional Projects.

Post-Treatment of Product Water (Permeate)

The same post-treatment processes with additional treatment capacity would be required for the Regional Project. For the 60 MGD Regional Project, the product water storage tank (referred to as a clearwell) has been sized for 10.0 MG to provide 4 hours of contact time plus approximately 1.4 MG of operational storage, for a total of 11.4 MG.

Desalinated Water Storage and Pumping

Desalinated water would be stabilized and dosed with chloramine before it enters the product water storage tank. For the 60 MGD Regional Project, two additional 3.8 MG storage tanks would be installed beneath the RO Buildings underneath the desalinated water pump station. The desalinated water pump station would use vertical turbine pumps with floor-mounted motors to pump desalinated water into a new pipeline that would convey the desalinated water to the distribution system. For the 60 MGD Project, the 67.5 MGD pump station would operate at approximately 7,200 HP (5,600 kW).

Surge control facilities, consisting of several hydro-pneumatic tanks, would be required to protect the pump station and pipeline system from hydraulic transients and surges. The surge tanks would be connected to the discharge of the pump station and would be located as close as possible to the pump station.

Residuals Handling and Disposal

Residuals handling processes for waste backwash treatment and solids residuals handling for the Regional Project would be the same except that the facilities would be incrementally larger than those described for the Local Project. Although the amount of CIP waste generated by the 60 MGD Project would be approximately three times more than for the Local Project, it is expected that CIPs would be staggered to limit the maximum daily discharge to be the same volume as for the Local Project.

Chemical Storage and Handling

Chemical storage and handling facilities for the Regional Project would be housed in the same facilities built by the Local Project. The footprint of the facilities would not change with the expansion to the Regional Project. On-site storage of chemicals would be sufficient for 10 to 20 days of usage at average dosage rates.

Administration/Operations Building

The Administration/Operations Building would not change with expansion to the Regional Project.

Power Supply and Distribution

Power to the desalination facility would be provided via overhead power lines directly from SCE. One or more electrical substations would be required to lower the voltage from service voltage to site distribution voltage. Electrical power supply required for the desalination facility and ancillary intake pump station and desalinated water pump station is estimated at 40 MW for the 60 MGD Regional Project (see **Table 3-4**). It is anticipated that the Regional Project would require this power continuously, resulting in a total annual demand for 323,244 MWh per year.

Utility Connections

Utility connections for the Regional Project would be the same to those described for the Local Project.

TABLE 3-4
REGIONAL PROJECT SUMMARY OF ELECTRICAL POWER SUPPLY REQUIREMENTS (MW)
(INCLUDES LOCAL PROJECT)

Component	Regional Project Estimated Power Supply Requirements (MW)
Intake and Pretreatment	2.7
First-Pass Reverse Osmosis ¹	25.0
Second-Pass Reverse Osmosis ¹	1.7
Post-Treatment	0.2
Distribution (On-Site + Off-Site)	5.7 + 2.2
Residuals and Other	1.0
Miscellaneous	0.3
TOTAL	38.8

NOTES:

These are preliminary estimates for purposes of CEQA analysis and may be modified during the Project's regulatory permitting, final design, and/or construction process.

¹ Energy consumption is estimated based on the use of energy recovery devices (ERD).

Screened Ocean Intake and Concentrate Discharge

Ocean Intake Facilities

The total intake volumetric flow for the 60 MGD Regional Project would be 126.6 MGD if the ocean water desalination facility uses GMF pretreatment and 136.2 MGD if the facility uses HRGMF/MF pretreatment. The intake flow would be reduced to approximately 123 MGD if treated backwash water is internally recycled.

An additional up to 8 wedgewire screens would be attached to the additional risers installed during construction of the Local Project. Since these risers would already be installed, impacts of installation would be minimal. The pipeline portals within the intake structure would be opened to use all five of the 42-inch HDPE pipelines installed during the construction of the Local Project. Figure 3-16d illustrates the proposed Regional Project configuration.

Onshore Intake Facilities

Ocean water from the existing tunnel would be conveyed to the desalination facility via a system of an intake pump station and onshore pipelines. The intake pumping capacity for the 20 MGD Local Project would be expanded to accommodate the 60 MGD Regional Project. Ocean water would be pumped by the intake pump station with larger pumping capacity to the pretreatment facility. Expansion of the intake pump station from the initial 20 MGD phase to accommodate the Regional Project would involve adding additional pumps to increase pumping capacity to 126–136 MGD (depending on the pretreatment process that is used) within the same structure. The pumps would have a total combined horsepower of at least 2,300 HP (for a desalination facility at the ESGS North Site) to 3,000 HP (for a desalination facility at the ESGS South Site), plus appropriate standby capacity.

For the ESGS South Site, ocean feedwater would be conveyed directly to pretreatment system facilities via two buried parallel HDPE pipelines 2,100 feet in length. At least one of these pipelines would have been installed for the initial 20 MGD Local Project. For the ESGS North Site, feedwater would be pumped directly into adjacent pretreatment facilities.

Ocean Concentrate Discharge Facility

For the 60 MGD Regional Project, the normal amount of flow to be discharged from the ocean desalination facility would be approximately 76.2 MGD, which would be composed of approximately 62.7 MGD of RO concentrate (brine), and 13.5 MGD of treated backwash water from the HRGMF and MF processes. If the washwater is internally recycled, the normal discharge flow would be reduced to approximately 63 MGD with 62.7 MGD from the RO process and 0.1 MGD from the washwater recycling process (Figure 3-7). If a GMF process is used for pretreatment, and washwater is not internally recycled, the typical total discharge volumetric flow would be approximately 67.2 MGD, composed of 62.7 MGD of brine and 4.5 MGD of treated backwash water from the GMF process. If washwater is internally recycled, the normal discharge flow would be approximately 63 MGD, composed of 62.7 MGD of RO brine and 0.3 MGD from the washwater recycling process (Figure 3-8).

At times, during startup and infrequently during upsets while the plant is in operation, it may be necessary to bypass the entire feedwater flow system to discharge. Depending on pretreatment processes and washwater recycling, the discharge system would be sized for a peak discharge of 83 to 95 MGD.

The five discharge pipelines would be used to convey concentrate to the multi-port diffuser previously installed on the existing discharge tower. A total of eight duckbill diffuser ports, which would be installed during construction of the Local Project, would be used. Only four ports would be used for the Local Project. The remaining four ports would be commissioned during the construction phase of Regional Project to meet accommodate the additional volumetric flow. The diffuser ports would be positioned approximately 20 feet below the ocean surface at Mean Lower Low Water. They would be designed at different vertical angles than the Local Project for lower velocity discharge in order to comply with California Ocean Plan dilution requirements. Figure 3-18d illustrates the proposed Regional Project configuration.

Onshore Discharge Facilities

For a desalination facility located at the ESGS North Site which has a relatively low elevation, a 95 MGD 500 HP discharge pump station would be required to deliver normal and bypass operation flows and to provide sufficient hydraulic head to maintain a desired exit velocity at the diffuser nozzles. A desalination facility located at the ESGS South Site would be located at a higher elevation and the discharge could flow by gravity through the discharge piping to the discharge diffusers.

Desalinated Water Conveyance Facilities

For the Regional Project, a 48-inch- or 54-inch-diameter Regional Pipeline would be extended from the 54-inch Local Project Pipeline within El Segundo Boulevard to a connection on MWD's existing Sepulveda Feeder on Van Ness Boulevard. The alignment for the Regional Pipeline would be one of the variant alignments shown in Figure 3-5. A regional pump station would also be required somewhere along the Regional Pipeline alignment in order to provide the additional pressure needed to connect to the Sepulveda Feeder. This regional pump station could be sized for up to 67.5 MGD to allow for all flow from the desalination facility to be pumped to the Sepulveda Feeder. The alternative pipeline corridors for the Regional Pipeline and five potential sites for the regional pump station are shown in Figure 3-5.

3.5 Local Project Construction

Construction (including demolition and site preparation) and commissioning of the 20 MGD Local Project would require up to 72 months and is assumed to commence in 2021, with completion estimated by 2027 (depending on the selected site). Various types of construction activities would be required, as described below. Given that the project design is still at conceptual stage, design criteria and field data required to determine construction technique and technologies are unavailable. The descriptions provided below provide conservative assumptions of construction techniques and technologies that may be selected.

3.5.1 Ocean Water Desalination Facility Construction

Construction activities for the Local Project ocean water desalination facility on the ESGS South Site would require approximately 15 months of site excavation and preparation and approximately 45 months of construction of the desalination facility, discharge pump station, and desalinated water pump station. The ESGS North Site construction activities would require approximately 6 months of demolition of existing NRG Units 3 and 4, approximately 15 months of site excavation and preparation, and approximately 32 months of construction of the desalination facility (53 months). Work is anticipated to occur 5 days per week from 7 AM to 6 PM. Construction worker trips would be expected to occur before 7 AM in the morning and either before 4 PM or after 6 PM in the afternoon and would therefore occur outside the peak traffic hours (generally the peak hour of traffic occurs between 7 AM and 9 AM in the morning and 4 PM and 6 PM in the afternoon). However, some demolition and materials removal or import may need to occur during the night for oversized loads. Oversized loads and other heavy-duty vehicles would primarily get to and from the site using main traffic conduits such as Vista Del Mar and Imperial Highway except for special circumstances to minimize traffic load in

residential areas. Construction workers and equipment would access the site via the existing ESGS access road. It is anticipated that West Basin would use a shuttle service for construction workers to reduce construction worker traffic and facilitate site access. Construction activities would include:

- Demolition and removal of existing NRG Units 3 and 4 (ESGS North Site) would involve:
 - Removal of any asbestos and hazardous materials.
 - Demolition of Unit 3 and 4 structures.
 - Pull down Units 3 and 4 (20 to 90 feet tall—these are the main power plant structures and exhaust stacks).
 - Demolish at-grade and below-grade concrete foundations. This would require excavations ranging from 5 to 20 feet deep. It is anticipated that groundwater control would be provided for these excavations such that the base would be stable for placing structural fill.
 - Crush on-site asphalt/concrete rubble.
 - Haul asphalt, concrete, and other demolition wastes.
- Initial excavation:⁶
 - For the ESGS South Site, initial excavation and export of 300,000 CY of material, of which approximately 120,000 CY would be brought back (or stockpiled on site) for backfilling completed structures. Backfill could be stored on-site at the Potential Construction Staging/Laydown Area identified in Figure 3-5 or at a number of off-site staging areas; refer to **Figure 3-21**. Dewatering of the excavated area may be required.
 - For the ESGS North Site, initial excavation of 120,000 CY of material, of which approximately 85,000 CY would be exported, and 35,000 CY would be temporarily stored on the ESGS South Site. This temporary stockpile would be used to backfill completed structures. Dewatering of the excavated area may be required (see discussion in Section 5.8).
 - Pile driving (if necessary) (ESGS North and South Sites).
- Construction of deep reinforced concrete hydraulic structures. These activities may include ground improvement measures, deep foundation construction, constructing foundation mats, or laying pipes.
- Backfilling of deep hydraulic structures. Structural fill would be brought up to the new construction site working grade.
- Construction of buildings for the various process and non-process components.
- Installation of mechanical and electrical equipment.
- Grading and paving of site circulation roads and parking areas.
- Landscaping and revegetation.

Construction staging areas would be required for all phases of construction. For construction of the ESGS North Site, the ESGS South Site would serve as the location for construction staging

⁶ Depending on the amount of soil that is contaminated, the amount of excavated soil reused on-site could vary. However, this Draft EIR analyzes the worst-case scenario of soil export and reuse (and associated truck trips).

and construction personnel parking. For construction on the ESGS South Site, a suitably sized (minimum 3 acres) off-site location would be required. Potential laydown/staging areas for the proposed Project are shown in Figure 3-21. It is anticipated that West Basin would use a shuttle service for construction workers to reduce construction worker traffic and facilitate site access.

Table 3-5 includes the construction activity assumptions associated with the different phases of ocean water desalination facility construction, construction equipment required, associated vehicle trips, and duration of activities. See **Figure 3-22** for a detailed schedule of construction activities associated with the Local Project.

**TABLE 3-5
LOCAL PROJECT OCEAN WATER DESALINATION FACILITY ONSHORE CONSTRUCTION ASSUMPTIONS**

Component	Construction Activity	Construction Equipment	Vehicle Trips	Local Project Schedule/Duration
Demolition of Existing NRG Units 3 and 4 (North Site Only)				
Demolition	<ul style="list-style-type: none"> Removal of any asbestos and hazardous materials Demolition of structures Pull down units Demolish at-grade and below-grade concrete foundations Crush on-site asphalt/concrete rubble Haul asphalt, concrete, and other demolition wastes Estimated amount of material to be hauled away: 80,000 CY 	<ul style="list-style-type: none"> Concrete/Industrial Saws: 1 Excavators: 3 Rubber Tires Dozers: 4 Tractors/Loader/Backhoes: 3 	<ul style="list-style-type: none"> 0 delivery trips per day 30 worker commute trips per day 5,715 one-way haul trips for export 	Months 1 to 6 (129 working days)
Intake/Discharge terminus				
Demolition	3,700 CY of terminal Structure 300 cy of concrete pad. Total 8,000 tons of export	<ul style="list-style-type: none"> Concrete/Industrial Saws: 1 Excavators: 3 Rubber Tires Dozers: 4 	<ul style="list-style-type: none"> 0 delivery trips per day 20 worker commute trips per day 791 one-way haul trips for export 	Months 7 to 9 (66 working days)
Site Preparation	6,000 CY of export	<ul style="list-style-type: none"> Rubber Tires Dozers: 3 Tractors/Loaders/Backhoes: 4 	<ul style="list-style-type: none"> 18 worker commute trips per day 750 one-way haul trips for export 	Months 10 and 11 (44 working days)

Component	Construction Activity	Construction Equipment	Vehicle Trips	Local Project Schedule/Duration
Grading	5,000 CY for pipeline insertion pit 5,000 CY for intake pump station Total 10,000 cy export	<ul style="list-style-type: none"> Excavators: 2 Graders: 1 Rubber Tires Dozers: 1 Scrapers: 2 Tractors/Loaders/Backhoes: 2 	<ul style="list-style-type: none"> 20 worker commute trips per day 1,250 one-way haul trips for export 	Months 12 to 14 (66 working days)
Intake Pump Station Construction	Structural concrete Structural steel Installation of mechanical and electrical equipment	<ul style="list-style-type: none"> Forklifts: 1 Generator Sets: 1 Tractors/Loaders/Backhoes: 1 Welders: 1 	<ul style="list-style-type: none"> 20 worker commute trips per day on average 	Months 15 to 37 (500 working days)
Desalination Facility Site Work (20 MGD Local Project)				
Initial Site Work and Ground Improvements	South Site ¹ : <ul style="list-style-type: none"> 300,000 CY excavation 300,000 CY export 120,000 CY import/fill 	<ul style="list-style-type: none"> Excavators: 2 Graders: 1 Rubber Tires Dozers: 1 Scrapers: 2 Tractors/Loaders/Backhoes: 2 	<ul style="list-style-type: none"> 0 delivery trips per day 20 worker commute trips per day 52,500 one-way haul trips for import/export 	Months 10 to 25 (303 working days)
Initial Site Work and Ground Improvements	North Site <ul style="list-style-type: none"> 120,000 CY excavation 85,000 CY export 35,000 CY import/fill 	<ul style="list-style-type: none"> Excavators: 2 Graders: 1 Rubber Tires Dozers: 1 Scrapers: 2 Tractors/Loaders/Backhoes: 2 	<ul style="list-style-type: none"> 0 delivery trips per day 20 worker commute trips per day 15,000 one-way haul trips for import/export 	Months 10 to 25 (303 working days)
Underground Piping	Trenching/jack-and-boring/directional drilling (North Site)	<ul style="list-style-type: none"> Concrete/Industrial Saws: 1 Excavators: 1 Rubber Tired Dozers: 1 Directional Drill Rig: 1 (assume used for ~2 months only) 	<ul style="list-style-type: none"> 0 delivery trips per day 15 worker commute trips per day 	Months 15 to 28 (200 working days)
	Trenching/jack-and-boring/directional drilling (South Site)	<ul style="list-style-type: none"> Concrete/Industrial Saws: 1 Excavators: 1 Rubber Tired Dozers: 1 Directional Drill Rig: 1 (assume used for ~2 months only) 	<ul style="list-style-type: none"> 0 delivery trips per day 15 worker commute trips per day 	Months 15 to 28 (200 working days)

Component	Construction Activity	Construction Equipment	Vehicle Trips	Local Project Schedule/Duration
Desalination Facility Construction				
	Foundation installation/deep reinforced concrete hydraulic structures	<ul style="list-style-type: none"> • Cranes: 1 • Forklifts: 3 • Generator Sets: 2 • Tractors/Loaders/Backhoes • Welders 		Months 24 to 37 (300 working days)
	Building construction (North Site) Structural concrete Structural steel	<ul style="list-style-type: none"> • Cranes: 1 • Forklifts: 3 • Generator Sets: 3 • Tractors/Loaders/Backhoes: 3 • Welders: 4 		Months 38 to 64 (580 working days)
	Building construction (South Site) Structural concrete Structural steel	<ul style="list-style-type: none"> • Cranes: 1 • Forklifts: 3 • Generator Sets: 3 • Tractors/Loaders/Backhoes: 3 • Welders: 4 		Months 38 to 64 (580 working days)
	Mechanical and electrical equipment installation	<ul style="list-style-type: none"> • Cranes: 1 • Forklifts: 3 • Generator Sets: 3 • Welders: 4 		Months 45 to 64 (400 working days)
	Startup/Commissioning/Performance Testing	<ul style="list-style-type: none"> • No additional equipment 		Months 54 to 64 (200 working days)
	Paving including access roads	<ul style="list-style-type: none"> • Pavers: 1 • Paving Equipment: 1 • Rollers: 1 		Month 64 (20 working days)

NOTES:

¹These assumptions are conservative. However, based on existing reports, it appears that the contamination is relatively shallow and that on-site reuse of the excavated materials is likely which would substantially reduce trips.

3.5.2 Screened Ocean Intake and Concentrate Discharge Facilities Construction

Ocean Intake and Concentrate Discharge

Construction of the ocean intake and concentrate discharge system would require approximately 3 years, and is anticipated to occur in parallel with ocean water desalination facility construction. Installation of the intake screens and discharge diffusers requires that barges, support vessels, equipment and crew be mobilized offshore of the plant. Construction operations include vessel anchoring, dredging, riprap reconfiguration, existing intake and discharge intake modification, and pile driving.

Construction Vessels

The primary piece of heavy equipment needed for site preparation, installing the intake screens and discharge diffusers, and stockpiled riprap placement is a large derrick barge with a crane on deck. This derrick barge would be between approximately 150 feet wide and 300 feet long and the crane on the deck of the derrick barge would be between 120-ton and 300-ton class. Smaller crew and supply vessels from the Port of Los Angeles (POLA) or Port of Long Beach (POLB) or closer harbors (e.g., Marina del Rey or King Harbor) would shuttle workers to the offshore work site two times daily (additional trips may be needed to deliver equipment and supplies) and perform environmental monitoring.

The intake screens and discharge diffusers would be transported out to the derrick barge via a separate tug and transport (deck) barge from the POLA/POLB, and would likely require three to four round-trips to the site. Additional tug boats and deck barges would also be needed to temporarily hold the stockpiles of riprap retrieved from the seafloor around the intake and discharge structures until the stone is replaced around the modified structures. The deck barges holding the riprap may be towed back to the POLA/POLB if deemed necessary due to weather or other conditions, which would require another three to five round-trips to the site depending on the size of barges available. The deck barges range in length between approximately 200 and 300 feet long by up to 50 feet wide, and the support tugs are up to 90 feet long.

Site Preparation

Anchoring

Anchoring is required during construction to ensure that the derrick barge and other offshore equipment remain stationary. The contractor would identify and map all areas of kelp, seagrasses, and hard substrate found within the work area, to avoid or minimize construction and operational impacts by anchors, buoys, cables, riprap, and dredging spoils during the Project construction and maintenance.

Temporary mooring buoys for the derrick barge, as shown in **Figure 3-23**, would be used and located to prevent anchor wires from dragging on the bottom and wearing against existing pipelines. Anchors and associated gear would be retrieved upon completion of construction. If the installation of the new pipes within the existing intake and discharge pipes is required, the derrick barge would need to be repositioned about 1,500 feet offshore of whichever tower was being modified.

Riprap Reconfiguration

Installation of the intake screen and discharge diffuser would require removing and reconfiguring an estimated 2,000 tons of riprap around the existing intake structure and similarly approximately 2,000 tons of riprap around the discharge pipeline tower structure. The riprap surrounding both the intake and discharge towers would be removed and temporarily stockpiled on the seafloor. If this is infeasible, the riprap would be stockpiled on barges which would then likely be towed to the POLA/POLB to store the riprap in harbor during construction. After installation of the new intake header pipe and discharge diffusers, the stockpiled riprap would be placed around the modified intake and diffuser structures. The final post-construction riprap footprint area will be approximately the same as the existing benthic footprint.

Dredging around the Intake Tower

Installation of the intake screens and header piping and the new HDPE piping inside the existing 12-foot intake pipe requires that the seafloor be dredged (excavated by barge mounted crane with a clamshell bucket) approximately 20 feet below the existing seafloor. Up to 21,646 CY of sediment would be excavated and stockpiled on the seafloor adjacent to the intake tower, with an approximate intake tower dredge area of 1.50 acres. The associated stockpile area adjacent to the intake tower excavation would be approximately 3.35 acres (assuming 4 feet of material above seafloor to maintain stability) for a total cumulative disturbance area of 4.85 acres. A schematic of the intake dredging footprint is shown in **Figure 3-24**. Dredge volume quantities are included in **Table 3-6**.

**TABLE 3-6
OFFSHORE DREDGE VOLUMES**

Scenario	Subset	Volume of Dredge Material	Dredge Footprint	Stockpile Footprint	Cumulative Disturbed Footprint
Intake	12 Intake Screens	21,646 CY	1.50 acres	3.35 acres	4.85 acres
Discharge		13,608 CY	0.98 acres	2.11 acres	3.09 acres

SOURCE: GHD 2017

Dredging around the Discharge Tower

Installation of the discharge diffusers and the new HDPE piping inside the existing 12-foot intake tunnel would require that the seafloor be dredged (excavated by barge mounted crane with a clamshell bucket) approximately 20 feet below the existing seafloor. Up to 13,608 CY of sediment would be excavated and stockpiled on the seafloor adjacent to the discharge tower, with an approximate discharge tower dredge area of 0.98 acres. The associated stockpile area adjacent to the intake tower excavation would be approximately 3.09 acres assuming 4 feet of material above seafloor to maintain stability. A schematic of the discharge dredging footprint is shown in **Figure 3-25**. Refer to Table 3-6 for dredge volume quantities associated with discharge activities.

To perform the prescribed modifications to the intake and discharge facilities, up to approximately 8 acres of seafloor would need to be temporarily disturbed.

Dredge Disposal Options

Sediment samples would be taken in the area of seafloor disturbance to determine if any contaminants are present in the material to be displaced. If the material is clean, temporary stockpiling of the dredge material on-site (on the bottom of the ocean floor) as described above is the preferred option. A second option is to take the clean material to the LA-2 Ocean Dredged Material Disposal Site adjacent to the POLA/POLB, if the material is determined to be compatible. For off-site disposal, assuming there would be a total of 35,254 CY of dredged material, a dump scow with a capacity of 800 CY of dredge material would produce 45 barge

round-trips, whereas using a larger 2,000 CY dump scow would produce approximately 18 barge round-trips from the site.⁷

Pile Driving

A single or double row of piles would be installed to help guide into place and support the intake pipe header underneath the intake screens. It is anticipated that a total of 6 to 12 steel or fiberglass pipe piles (12- to 16-inch-diameter, for a total for 40 feet) would be installed in the seafloor using barge mounted pile driving equipment. The duration of installation would be approximately 3 to 5 working days depending on weather and/or construction sequencing by the contractor. It is anticipated that each pipe pile would require approximately 4 hours for high-resistance driving with a hammer for the full 35-foot embedment.

The proposed method of pile installation for this Project is driving the piles into the seafloor with a vibratory driver/extractor. For this type of driving, vibrations are transferred from the hammer to the pile at a high enough frequency to liquefy unconsolidated sandy soil around it, allowing the pile to sink downward into the sediment as the crane lowers the driver/extractor. Although not anticipated, if difficult driving is encountered at the site and installation of the pile meets refusal, the use of an impact hammer may be warranted to drive the pile to design tip elevation.

Installation of the Intake Screen System and Diffuser Ports

Construction and installation of the pipe manifold, intake screens and associated infrastructure such as the new HDPE pipe in the existing 12-foot concrete intake tunnel would take approximately 6 months. Work would be conducted from the same derrick barge moored above the intake tower and would be confined to the area directly surrounding the tower. The wedgewire intake screens would be fabricated at an off-site location, shipped to the POLA/POLB, loaded onto a transport barge, and then towed to the site for installation offshore. Onshore support vehicles at the selected port may include pick-up trucks, a forklift, a crane, and a wheel loader. Construction crews and vessels would vary depending on the scope of work occurring each day. The number of crew members present will be the same as that described for the diffuser system unless installation of the diffuser occurs concurrently with the installation of the intake screens. In that case, a set of vessels and crew would work at each site.

The existing intake and discharge structures at the end of each of the 12-foot tunnels would be exposed by dredging to provide access. Underwater divers would cut holes in the end of each tunnel terminus structure to allow for the five 42-inch-diameter HDPE pipes to be inserted into the tunnel from the offshore end to the shore. The HDPE pipe would be stockpiled on the barges and positioned to be lowered by the crane to the ocean floor where divers would guide it into the tunnels. The HDPE pipe segments would be welded together on the barge as the pipe is inserted into the tunnels. This process would occur for both the intake and discharge tunnels.

⁷ Since the proposed offshore dredging location has not been identified as a hot-spot for contaminants, it is assumed offshore sediment disposal will be appropriate for the majority of the sediment. As such, land-based disposal of dredged material is not analyzed in this EIR. If portions of the dredged material do not meet agency criteria, the material could be offloaded at the POLA/POLB for disposal in an appropriate land-based facility. It is assumed that any contaminated material would be minimal compared to the total amount of clean dredged material disposed of offshore.

The proposed process for installing the intake screen system is described below and shown in Figure 3-16c.

1. The existing intake tower velocity cap and riprap are shown in cross-section. Riprap surrounding the tower would be removed and temporarily stockpiled on the seafloor. If this is infeasible, the riprap would be stockpiled on barges, which would then likely be towed to the POLA/POLB to store the riprap in harbor during construction.
2. Dredging would occur around the intake tower and along the alignment of the new pipe header, to facilitate the installation of the new HDPE piping inside the existing 12-foot-diameter concrete intake pipe.
3. The exposed face of the intake tower opposite the existing intake pipe would be chipped out by divers using hydraulic/pneumatic drills, chisels, and saws. The removed concrete and rebar would be raised to the surface and placed on the barge for land disposal. The new HDPE piping would be installed inside the existing 12-foot-diameter concrete intake pipe. The new pipes would be pressure-tested using raw seawater to confirm that pipe joints are sealed properly.
4. New foundation piling would be driven into the seafloor to help guide into place and support the pipe header underneath the intake screens. Supports for the pipe saddle (the supporting foundation upon which the pipe header would be installed) would be set on top of the piles.
5. A layer of bedding stone would be placed around the saddles to protect against erosion, and the pipe header would be strapped to the top of the saddle supports and connected to the intake structure.
6. Previously removed and stockpiled sediment would carefully be placed around the intake tower and pipe header with a clamshell bucket.
7. The existing velocity cap would be demolished; the demolition would be done by divers using pneumatic drills, chisels, and saws to cut and break up the concrete into manageable-sized pieces. The derrick barge crane would be used to lift the demolished concrete and rebar from the top of the intake tower.
8. The temporarily stockpiled riprap (if any) would be removed from the barges and placed on the seafloor with a clamshell bucket around the intake tower.
9. Up to four wedgewire intake screens would be secured to the top of the header pipe to meet the local demand flow condition.
10. An additional three intake screens would be installed for the Regional Project (should that project proceed), for a total of up to 12 wedgewire screens. (Note: The exact number and diameter of screens is subject to change as design progresses.)

The intake screen and discharge diffuser modifications may occur concurrently or separately depending on the availability of the wedgewire screens and diffuser nozzles, equipment, and contractor means and methods. The new diffuser system would be installed from the derrick barge with the crane moored above the discharge tower during construction. Offshore work would be confined to the area directly above and surrounding the existing discharge tower, and installation of the diffuser system would take approximately 5 months.

Table 3-7 includes the construction activities associated with the different phases of screened ocean intake and concentrate discharge construction, construction equipment required, associated

vehicle trips, and duration of activities. See Figure 3-22 for a detailed schedule of construction activities associated with the Local Project.

**TABLE 3-7
LOCAL PROJECT OFFSHORE CONSTRUCTION ASSUMPTIONS**

Component	Construction Activity	Construction Equipment	Vehicle/Vessel Trips	Schedule/Duration (Pipe-in-Pipe)	Schedule/Duration (No Pipe-in-Pipe)
Offshore Construction					
Mobilization					
	Mobilization	<ul style="list-style-type: none"> • Derrick Barge w/ Crane • Support Barges (up to 5 total) • Tug Boats (up to 3 at a time) • Crew/Survey Boats (up to 4 at a time) • Bio-monitoring Boat • Cable Winch (onshore) • Excavator (onshore) 	<ul style="list-style-type: none"> • Tow derrick barge and crane offshore from Port of Los Angeles/ Long Beach • Tow support barge(s) offshore from Port of Los Angeles/Long Beach • Set anchors using 2 tugs to assist barge and crane for 4 of 30 days • Barge anchored for 26 of 30 days • Crew vessels performing 2 to 3 trips per day 	Month 1 (30 calendar days)	Month 1 (30 calendar days)
Pipeline Inserts (discharge and intake)					
	<p>Pipe welded together onshore then towed to site (Approx. 14,000 feet of 42 inch OD HDPE pipe for intake) (Approx. 11,500 feet of 42 inch OD HDPE pipe for discharge)</p>	<ul style="list-style-type: none"> • Same as mobilization minus a support barge and add two extra tugs • Shore crew excavating around piping with tracked excavator and setting up winch system to pull pipe in pipe 	<ul style="list-style-type: none"> • Barge anchored for 60 days • Tow support pipe offshore from either a local beach or the Port of Los Angeles/Long Beach for up to 8 trips • 1 support barge at anchor offshore to accommodate final welding of long sections of pipe towed offshore • Crew vessels performing 2 to 3 trips per day 	<p>Months 2 and 3 for the intake piping (60 calendar days) Months 8 and 9 for the discharge piping (60 calendar days)</p>	Not applicable

Component	Construction Activity	Construction Equipment	Vehicle/Vessel Trips	Schedule/Duration (Pipe-in-Pipe)	Schedule/Duration (No Pipe-in-Pipe)
	Installation	<ul style="list-style-type: none"> • Same as mobilization 	<ul style="list-style-type: none"> • Barge anchored for 60 days for intake and 45 days for discharge pipe installation • Tow support barge(s) offshore from the Port of Los Angeles/Long Beach loaded with pipe and appurtenances for up to 20 trips • 2 to 3 support barges at anchor offshore to accommodate welding of pipe • Crew vessels performing 2 to 3 trips per day 	<p>Months 4 and 5 for the intake piping (60 calendar days)</p> <p>Months 10 to 11.5 for the discharge piping (45 calendar days)</p>	Not applicable
Ocean Intake Screen Installation					
Site Preparation					
	Excavation and dredging (Up to 18,000 CY of sediment for Intake) (Up to 2,000 tons of riprap stone around intake)	<ul style="list-style-type: none"> • Same as mobilization • Dredging may require use of a bottom dump scow or a submersible dredge pump to spread material around site evenly 	<ul style="list-style-type: none"> • Barge anchored for 45 to 60 days for riprap removal and dredging around intake structure • 4 to 5 support barges and 2 to 3 tugs at anchor offshore at a time to accommodate loading of riprap and dredge support • Tow support barges loaded with riprap to the Port of Los Angeles/Long Beach for up to 5 trips • Crew vessels performing 2 to 3 trips per day 	Months 2 and 3 (60 calendar days)	Months 2 to 3.5 (45 calendar days)
	Intake tower demolition	<ul style="list-style-type: none"> • Same as mobilization 	<ul style="list-style-type: none"> • Barge anchored for 15 to 30 days for dredging and riprap removal around intake structure • 1 to 2 support barges and tugs at anchor offshore at a time to accommodate concrete demolition • Tow support barge loaded with demolished concrete to the Port of Los Angeles/Long Beach (1 trip) • Crew vessels performing 2 to 3 trips per day 	Month 3 (30 calendar days)	Month 3 to 3.5 (15 calendar days)

Component	Construction Activity	Construction Equipment	Vehicle/Vessel Trips	Schedule/Duration (Pipe-in-Pipe)	Schedule/Duration (No Pipe-in-Pipe)
Installation					
	Pile driving (Up to 6 steel or fiberglass H-piles x 60 feet long each)	<ul style="list-style-type: none"> • Same as mobilization 	<ul style="list-style-type: none"> • Barge anchored for 15 days for pile driving • 1 support barge at anchor offshore at a time to accommodate pile installation • Crew vessels performing 2 to 3 trips per day 	Month 6 to 6.5 (15 calendar days)	Month 3.5 to 4 (15 calendar days)
	Intake tower modification and installation of header and wedgewire screens	<ul style="list-style-type: none"> • Same as mobilization 	<ul style="list-style-type: none"> • Barge anchored for 15 days for header and screen installation • 1 to 2 support barges and tugs at anchor offshore at a time to accommodate pile installation • Crew vessels performing 2 to 3 trips per day 	Month 6.5 to 7 (15 calendar days)	Month 4 to 4.5 (15 calendar days)
	Replacement of dredged material and riprap (Up to 18,000 CY of sediment for intake) (Up to 2,000 tons of riprap stone around intake)	<ul style="list-style-type: none"> • Same as mobilization 	<ul style="list-style-type: none"> • Barge anchored for 15 to 30 days for sediment and riprap replacement around intake structure • 4 to 5 support barges and 2 to 3 tugs at anchor offshore at a time to accommodate offloading of riprap and dredge support • Tow support barges loaded with riprap from the Port of Los Angeles/Long Beach for up to 5 trips • Crew vessels performing 2 to 3 trips per day 	Month 7 (30 calendar days)	Month 4.5 to 5 (15 calendar days)

Component	Construction Activity	Construction Equipment	Vehicle/Vessel Trips	Schedule/Duration (Pipe-in-Pipe)	Schedule/Duration (No Pipe-in-Pipe)
Ocean Discharge System					
Site Preparation					
	Excavation and dredging (Up to 18,000 CY of sediment for discharge) (Up to 2,000 tons of riprap stone around discharge)	<ul style="list-style-type: none"> • Same as mobilization • Dredging may require use of a bottom dump scow or a submersible dredge pump to spread material around site evenly 	<ul style="list-style-type: none"> • Barge anchored for 15 to 30 days for riprap removal and dredging around discharge structure • 4 to 5 support barges and 2 to 3 tugs at anchor offshore at a time to accommodate loading of riprap and dredge support • Tow support barges loaded with riprap to the Port of Los Angeles/Long Beach for up to 5 trips • Crew vessels performing 2 to 3 trips per day 	Months 8 (30 calendar days)	Month 5 to 5.5 (15 calendar days)
	Discharge tower demolition	<ul style="list-style-type: none"> • Same as mobilization 	<ul style="list-style-type: none"> • Barge anchored for 15 to 30 days for dredging and riprap removal around discharge structure • 1 to 2 support barges and tugs at anchor offshore at a time to accommodate concrete demolition • Tow support barge loaded with demolished concrete to the Port of Los Angeles/Long Beach (1 trip) • Crew vessels performing 2 to 3 trips per day 	Month 9 (30 calendar days)	Month 5.5 to 6 (15 calendar days)
Installation					
	Discharge tower modification and installation concrete lid with diffusers	<ul style="list-style-type: none"> • Same as mobilization 	<ul style="list-style-type: none"> • Barge anchored for 15 days for header and screen installation • 1 to 2 support barges and tugs at anchor offshore at a time to accommodate pile installation • Crew vessels performing 2 to 3 trips per day 	Month 11.5 to 12 (15 calendar days)	Month 6 to 6.5 (15 calendar days)

Component	Construction Activity	Construction Equipment	Vehicle/Vessel Trips	Schedule/Duration (Pipe-in-Pipe)	Schedule/Duration (No Pipe-in-Pipe)
	Replacement of dredged material and riprap (Up to 18,000 CY of sediment for discharge) (Up to 2,000 tons of riprap stone around discharge)	<ul style="list-style-type: none"> Same as mobilization 	<ul style="list-style-type: none"> Barge anchored for 15 to 30 days for sediment and riprap replacement around discharge structure 4 to 5 support barges and 2 to 3 tugs at anchor offshore at a time to accommodate offloading of riprap and dredge support Tow support barges loaded with riprap from the Port of Los Angeles/Long Beach for up to 5 trips Crew vessels performing 2 to 3 trips per day 	Month 12 (30 calendar days)	Month 6.5 to beginning of Month 7 (15 calendar days)

Daily personnel access would be provided via a crew/supply boat meeting USEPA Tier 2 or higher emission standards. Onshore support vehicles at the selected port may include pickup trucks, a forklift, a crane, and a wheel loader. Construction/dive crews and vessels would vary depending on the scope of work occurring each day.

- A day with lower activity levels would likely require approximately 12 crew members/divers: 10 for the derrick barge and support vessels, and 2 for a smaller monitoring boat for marine mammal and turbidity monitoring.
- A day with higher activity levels may require as many as 20 crew members/divers: 15 for a derrick and transport barge, 3 for a tug boat, and 2 for the monitoring boat.

The proposed process for installing the diffuser system is described below and shown in Figure 3-18d).

- The first illustration shows the existing cross-section view of the discharge tower, with a screen on the top of and riprap around the discharge tower.
- Riprap surrounding the tower would be removed and stockpiled on the seafloor. If this is not feasible, the riprap would be temporarily stockpiled on barges, which would then likely be towed to the POLA/POLB to store the riprap in harbor during the construction.
- Dredging would occur around the discharge tower and to facilitate the installation of the new HDPE piping inside the existing 12-foot-diameter concrete intake pipe. The new pipes would be pressure-tested using raw seawater to confirm that pipe joints are sealed properly.
- The exposed face of the discharge tower opposite the existing discharge pipe would be chipped out by divers using hydraulic/pneumatic drills, chisels, and saws. The removed concrete and rebar would be raised to the surface and placed on the barge for land disposal. The new HDPE piping would be installed inside the existing 12-foot-diameter concrete intake pipe.
- The chipped outside of the discharge tower would be sealed up and the previously removed and stockpiled sediment would be placed around the discharge tower with a clamshell bucket.

6. The top of the existing tower would then be sawcut and demolished. The extent of removal would be established so that the tower height with the new diffuser system in place would be at the same height of deeper than the existing discharge tower height.
7. The precast concrete diffuser cap would be constructed off-site, transported to the POLA/POLB, loaded on a transport barge, and towed to the site. The precast lid with cast-in ports for the diffusers and an access hatch would then be installed on top of the modified (shortened) tower. The previously stockpiled riprap would also be replaced around the diffuser tower at this time.
8. The diffusers would be installed on the concrete lid, with flexibility in their number and placement for both the local and regional flow demand.

3.5.3 Desalinated Water Conveyance Construction

The Local Project conveyance facility construction activities would last approximately 30 months and would occur 5 days per week from 7 AM to 6 PM. The following construction methods are assumed:

- Up to 9.3 miles of pipeline are proposed under the Local Project.
- Pipelines generally would be installed using open-cut trenching (construction typically proceeds at an average rate of approximately 150 feet per day); however, where this is infeasible, trenchless construction (jack-and-bore) would be used. See **Table 3-8** for estimated quantities of pipeline excavation and repaving.
- Trenchless construction (slant bore) would be required for the segment of the pipeline as it exits the desalination facility to Vista del Mar. Potential trenchless construction locations also include the intersections of El Segundo Boulevard and Sepulveda Boulevard; El Segundo Boulevard and I-405; West 120th Street and I-405; West 120th Street at Hawthorne Municipal Airport; Rosecrans Avenue and Aviation Boulevard; and Manhattan Beach Boulevard and the I-405.
- Construction equipment would include excavators, loaders, haul trucks, compaction equipment, water trucks, cranes, soil sorting and screening equipment, shoring systems, paving equipment, and welding equipment.
- Soils excavated would be reused to the extent possible or hauled for off-site disposal.
- Width of disturbance corridor would be up to 35 feet for open-trench construction. If damaged during construction, up to 35 feet of pavement width would be restored.
- Work area around jacking and receiving pits for the six potential jack-and-bore locations would be approximately 5,000 square feet each (e.g., 100 feet by 50 feet).
- Product water conveyance lines would be pressure-tested prior to their operation and would involve chlorinated potable water, with the resultant end product (as the pipes are flushed out and pressure-tested) being dechlorinated and discharged into the local storm drain system or as otherwise required by the Regional Water Quality Control Board (RWQCB) through its Waste Discharge Requirements permitting process.

**TABLE 3-8
LOCAL PROJECT EXCAVATION AND REPAVING FOR PIPELINE CONSTRUCTION**

Segment	Construction Method	Total Excavation (CY)	Exported Excavation (CY)	Repaving (Sq Ft)
Desalinated Water Pipeline to Inglewood Avenue, 25,400 LF	Open-Trench	101,000	47,500	750,000
Connection to East End of Existing WB Feeder, 23,500 LF	Open-Trench	65,000	21,000	560,000
Regional Pipeline, 25,800 LF	Open-Trench	97,000	41,000	760,000

NOTES:

These are preliminary estimates for the purposes of CEQA analysis and may be modified during the Project's regulatory permitting, final design, and/or construction process.

Table 3-9 includes the construction activities associated with the different phases of desalinated water conveyance facility construction, construction equipment required, associated vehicle trips, and duration of activities.

**TABLE 3-9
LOCAL PROJECT DESALINATED WATER CONVEYANCE CONSTRUCTION ASSUMPTIONS**

Component	Construction Activity	Construction Equipment	Vehicle Trips	Local Project Schedule/Duration
Demolition	63,815 tons of roadway demolition to export	<ul style="list-style-type: none"> Concrete/Industrial Saws: 1 Excavators: 3 Rubber Tires Dozers: 2 	<ul style="list-style-type: none"> 0 delivery trips per day 15 worker commute trips per day 6,310 one-way haul trips for export 	(500 working days)
Excavation, Trenching, Jack-and-Boring / Directional Drilling	101,000 CY for Desal Water Pipe to Inglewood Avenue 65,000 CY export for connection to East End of WB Feeder Modeled as 166,000 CY import and 68,500 CY export	<ul style="list-style-type: none"> Excavators: 2 Graders: 1 Rubber Tires Dozers: 1 Scrapers: 2 Tractors/Loaders/Backhoes: 2 Directional Drill Rig: 1 	<ul style="list-style-type: none"> 0 delivery trips per day 20 worker commute trips per day 29,313 one-way haul trips for export 	(500 working days)
Paving		<ul style="list-style-type: none"> Pavers: 2 Paving Equipment: 2 Rollers: 2 	<ul style="list-style-type: none"> 0 delivery trips per day 15 worker commute trips per day 0 one-way haul trips for export 	(450 working days)

3.6 Regional Project Construction

Construction and commissioning of the 60 MGD Regional Project would require approximately 36 months and would depend on the selected site. Commencement of Regional Project construction and precise phasing is unknown and would be determined based upon funding sources, financial partners, and specific end users of the additional water supply beyond 20 MGD. For purposes of the environmental analysis, Regional Project construction is assumed to commence in 2026 and last 36 months.

3.6.1 Ocean Water Desalination Facility Construction

Construction of the Regional Project ocean water desalination facilities would last approximately 36 months. Construction methods would be similar to the Local Project. Construction workers would access the site via the existing ESGS access road. Construction activities could include:

- Excavation:
 - For expansion of a desalination facility from 20 MGD to 60 MGD at the ESGS South Site, excavation and exporting of an additional approximately 65,000 CY of material would be required. The amount of this material to be returned to the site for backfill purposes would be negligible.
 - For expansion of a desalination facility from 20 MGD to 60 MGD at the ESGS North Site, excavation and exporting of an additional approximately 40,000 CY of material would be required, of which approximately 4,000 CY would be brought back to the site for backfilling around completed structures.
- Construction of buildings for the various process and non-process components
- Installation of mechanical and electrical equipment
- Grading and paving of site circulation roads and parking areas
- Landscaping and revegetation

3.6.2 Screened Ocean Intake and Concentrate Discharge

Construction of the Regional Project screened ocean intake and concentrate discharge facilities would last approximately 6 months. To reduce the amount of offshore construction impacts associated with the Project, offshore construction of the intake and discharge facilities would provide the portals necessary for future capacity expansions for the Regional Project. As a result, up to 12 wedgewire screen risers would be installed as shown in Figure 3-16b, with up to 4 of the 12 wedgewire screens installed during the Local Project. Similarly, eight diffuser ports would be installed under the Local Project, with four of the eight diffusers installed for operation of the Local Project. The five pipelines within the intake and discharge tunnels would also have been installed under the Local Project. The Regional Project would require the full intake and discharge capacity provided by the five pipe inserts. As a result, offshore construction would be limited to attaching additional wedgewire screens and diffusers onto pre-installed infrastructure. Construction methods would be similar to the Local Project.

3.6.3 Desalinated Water Conveyance Construction

The Regional Project conveyance facility construction activities would last approximately 24 months and are anticipated to occur 5 days per week from 7AM to 6 PM. Regional pump station pipeline construction at some future date would require an additional 2 to 3 years and would involve similar equipment and procedures.

- Up to 4.9 miles of additional pipeline are proposed under the Regional Project.
- Pipelines would be installed using open-cut trenching; however, if this is infeasible, trenchless construction (jack-and-bore) would be used.

- Construction equipment would include excavators, loaders, haul trucks, compaction equipment, water trucks, cranes, soil sorting and screening equipment, shoring systems, paving equipment, and welding equipment.
- Soils excavated would be reused to the extent possible or hauled for off-site disposal.
- Width of disturbance corridor would be up to 35 feet for open-trench construction.
- If damaged during construction, up to 35 feet of pavement width would be restored.
- Work area around jacking and receiving pits for the six potential jack-and-bore locations would be approximately 5,000 square feet each (e.g., 100 feet by 50 feet).
- Product water conveyance lines would be pressure-tested prior to their operation and would involve chlorinated potable water, with the resultant end product (as the pipes are flushed out and pressure-tested) being dechlorinated and discharged into the local storm drain system or as otherwise required by the Regional Water Quality Control Board through its Waste Discharge Requirements permitting process. Pressure piping in the raw water and brine discharge systems would be pressure-tested using unchlorinated seawater, and the resultant end product would be discharged into the ocean using Project brine discharge facilities.

Table 3-10 includes the construction activities associated with all applicable phases of the Regional Project construction, the construction equipment required, associated vehicle trips, and duration of activities.

**TABLE 3-10
REGIONAL PROJECT ONSHORE CONSTRUCTION ASSUMPTIONS**

Component	Construction Activity	Construction Equipment	Vehicle Trips	Regional Project Schedule/Duration
Treatment Plant Construction				
Excavation	South Site: 65,000 CY excavation 65,000 CY export N/A North Site 40,000 CY excavation 40,000 CY export 4,000 CY import/fill	Excavators: 2 Graders: 1 Rubber Tires Dozers: 1 Scrapers: 1 Tractors/Loaders/ Backhoes	0 delivery trips per day 20 worker commute trips per day 16,250 one-way haul trips for export	(88 working days)
Building Construction		Cranes: 1 Forklifts: 3 Generator Sets: 3 Tractors/Loaders/ Backhoes: 2 Welders: 3		(330 working days)

Component	Construction Activity	Construction Equipment	Vehicle Trips	Regional Project Schedule/Duration
Desalinated Water Conveyance				
Demolition	33,669 tons of roadway demolition to export	<ul style="list-style-type: none"> Concrete/ Industrial Saws: 1 Excavators: 3 Rubber Tires Dozers: 2 	<ul style="list-style-type: none"> 0 delivery trips per day 15 worker commute trips per day 3,329 one-way haul trips for export 	(500 working days)
Excavation, Trenching, Jack-and-Boring/ Directional Drilling	97,000 CY import 41,000 CY export	<ul style="list-style-type: none"> Excavators: 2 Graders: 1 Rubber Tires Dozers: 1 Scrapers: 2 Tractors/Loaders/ Backhoes: 2 Directional Drill rig: 1 	<ul style="list-style-type: none"> 0 delivery trips per day 20 worker commute trips per day 17,250 one-way haul trips for export 	(500 working days)
Paving		<ul style="list-style-type: none"> Pavers: 2 Paving Equipment: 2 Rollers: 2 	<ul style="list-style-type: none"> 0 delivery trips per day 15 worker commute trips per day 0 one-way haul trips for export 	(450 working days)

3.7 Project Operation and Maintenance

The proposed desalination facility would operate 24 hours a day, 365 days a year, and would be staffed around the clock. Routine deliveries of chemicals to the site, and hauling of residual materials from the site, would be conducted during normal day-shift working hours, during the traditional work week.

3.7.1 Staffing

The ocean water desalination facility would employ an anticipated total staff of roughly 20 full-time West Basin personnel, with the facility being fully staffed 8 hours per day, 5 days per week, and partially staffed at other times for the Local Project. Staffing levels for the Regional Project would be similar to Local Project, with the Regional Project requiring an additional up to four employees.

3.7.2 Visitors

As described previously, the proposed ocean water desalination facility would include space for facility administration, visitors, and public water education. It would include a reception area (with public education exhibits), administrative offices, conference room, restrooms, an auditorium with capacity for approximately 50 persons, lunchroom/kitchen, operations center, lockers, and a maintenance workshop. Parking for this facility would be a 14,000-square-foot single-level parking lot located adjacent to the administration/operations building.

3.7.3 Security

The proposed Project is located within ESGS boundaries. NRG currently maintains a physical security perimeter around the ESGS, including perimeter fencing, gates, and a guard-manned entry point. An access road to the desalination facility site would be constructed from the existing access road within the ESGS site, and would require all vehicles and visitors to pass through the existing ESGS guarded entry gate; see Figure 3-9, Figure 3-10, Figure 3-19, and Figure 3-20. Entry to desalination facility buildings would be further secured through lockable gates and doorways, and alarms (if necessary). Visitors of the education center would not be allowed outside of the established visitor area, unless escorted by a facility employee.

3.8 Permits, Approvals, and Regulatory Requirements

The ocean water desalination facility would require approvals from numerous Responsible Agencies, Trustee Agencies, and local agencies. **Table 3-11** lists the various agencies that will likely be consulted, along with anticipated permits and activities needed for consultation/permit approval.

3.9 Project Phasing

The proposed Project would be implemented through multiple construction phases. As described above, the 60 MGD Regional Project would be implemented through an initial phase of 20 MGD that would serve local water supply needs followed by incremental subsequent phases in 20 MGD increments (Phases 2 and 3) to meet water demands at a regional scale. Refer to Sections 3.5 and 3.6 for an expanded discussion on the construction phasing of the screened ocean intake, concentrate discharge, ocean water desalination facility, and desalinated water conveyance facilities under the 60 MGD Regional Project.

**TABLE 3-11
PERMITS, APPROVALS, AND REGULATORY REQUIREMENTS***

Agency/Department	Permit/Approval	Required for
Federal Agencies		
U.S. Fish and Wildlife Service (USFWS)	Section 7 consultation under the Endangered Species Act, Migratory Bird Treaty Act (MBTA) (16 USC §§ 703-711), and Fish and Wildlife Coordination Act (16 USC §§ 661-667c)	Required to address potential effects of Project construction and operation on any federally protected (i.e. endangered and threatened) plant/wildlife species or habitat.
NOAA National Marine Fisheries Service (NMFS)	Consultation in accordance with Section 7 ESA, Section 104 of the Marine Mammal Protection Act of 1972 (16 USC § 1374), and Section 305(b), Magnuson-Stevens Fishery Conservation and Management Act (16 USC § 1855 (b))	Required for interagency cooperation to avoid take of marine mammals and protect essential fish habitat. Required for concentrate discharge and any temporary work, construction, or operation in the marine environment.
U.S. Army Corps of Engineers (USACE)	Section 404 of the Clean Water Act (33 USC § 1344) and Section 10 of the Rivers and Harbors Appropriation Act (33 USC § 403)	Required for discharge of dredged or fill material into navigable waters of the United States (Section 7 Permit), structures in navigable waters (Section 10 Permit), and activities—including the placement of structures—affecting navigable waters (i.e., modifications to intake/discharge tunnels).
U.S. Coast Guard (District 11)	Local Notice to Mariners	Required for screened ocean intake and concentrate discharge facilities. Required for any temporary work, construction or operation in the marine environment that may affect vessels and waterways within Coast Guard District jurisdiction. Notice issued by Coast Guard for channel conditions, obstructions, menaces to navigation danger areas, etc.
State Agencies		
State Water Resources Control Board	Coverage Under National Pollutant Discharge Elimination System (NPDES) General Permit for Storm Water Discharges Associated With Construction Activity (General Permit) Water Quality Order 99-08-DWQ	Required for dischargers that could affect surface, coastal, or groundwaters whose projects disturb one or more acres of soil or whose projects disturb less than one acre but are part of a larger common plan of development that in total disturbs one or more acres. Specifically required for Project construction activity, which includes clearing, grading, and ground disturbances.
	California Ocean Plan consistency consultation and coordination with LARWQCB and other State agencies	Required pursuant to the SWRCB's Ocean Plan Amendment process.
California State Lands Commission (CSLC)	General Surface Lease (Right-of-Way Permit) (Pub. Resources Code Section 6000 et seq.; 14 Cal. Code Regs. Section 1900 et seq.)	Required for any construction occurring on CLSC lands, located below the Mean High Tide Line. Required to modify the existing ESGS SLC lease for use of the existing open-ocean intake system and allow the change in use/concentrate discharge.

Agency/Department	Permit/Approval	Required for
California Department of Fish and Wildlife (CDFW)	Lake/Streambed Alteration Agreement (Fish and Game Code § 1602)	Required for any activities that divert, change, or deposit debris, waste, or other materials within the bed, channel, or bank of any river, stream, or lake, including inland waters and within some areas of bays and estuaries (i.e., screened ocean intake and concentrate discharge facilities). Required for any activities that may substantially adversely affect existing fish or wildlife resources.
	California Endangered Species Act Consistency Determination (Fish and Game Code § 2081.1)	Required if the Project involves the potential for impingement/entrainment impacts to CDFW-listed candidate, threatened, or endangered species. Allows an Applicant who has obtained a federal incidental take statement pursuant to Section 7 consultation (or other federal take permit) to request CDFW Consistency Determination for consistency of federal documents with CESA.
California Coastal Commission (CCC)	Coastal Development Permit in accordance with the California Coastal Act (Pub. Res. Code § 30000 et seq.)	Required for marine-related improvements that change the intensity of land use within the Coastal Zone. Required for Project development proposed on tidelands, submerged lands, and public trust lands (i.e., screened ocean intake and concentrate discharge facilities).
California Division of Drinking Water (DDW)	Permit to Operate a Public Water System (Health and Safety Code § 116525)	Required prior to operation for potable use of the desalinated water (public water system).
California Department of Parks and Recreation Office of Historic Preservation	Coordination under Section 106 of the National Historic Preservation Act (16 USC § 470 et seq.)	Required for any Project activities subject to federal approval that may impact historic properties, which meet the criteria in the National Register of Historic Places or criteria for the National Register. Pertains to historic-period ESGS power plant.
California Department of Transportation (Caltrans)	Encroachment Permit (Streets & Highway Code § 660 et seq.)	Required for desalinated water conveyance components that would be installed within State highway right-of-ways under Caltrans jurisdiction.
California Department of Toxic Substances Control	Hazardous Waste Identification Number	Required for the ocean water desalination facility. Pertains to anyone who generates, transports, offers for transport, treats, stores, or disposes of hazardous waste.
	Groundwater Remediation (if required)	May be required for construction dewatering should groundwater require remediation.
California Energy Commission (CEC)	Application for Certification (AFC) Consistency Determination Permit modification as needed	Required to determine if demolition would be consistent with approved 00-AFC-14C for the existing ESGS power plant. Modification of existing energy facility to accommodate Project

Agency/Department	Permit/Approval	Required for
Regional Agencies		
Los Angeles Regional Water Quality Control Board (LARWQCB)	Coverage under NPDES Permit (Order No. R4-2012-0175, NPDES Permit No. CAS004001, <i>Waste Discharge Requirements for Municipal Separate Storm Sewer System [MS4] Discharges Within the Coastal Watersheds of Los Angeles County, Except Discharges Originating from the City of Long Beach [MS4]</i>)	Required for all Project facilities that would result in post-construction stormwater discharge.
	NPDES Permit in accordance with Clean Water Act Section 402 (33 USC § 1342)	Required for post-construction brine concentrate discharge and construction dewatering.
	Waste Discharge Requirements (WDR) in accordance with the Porter-Cologne Water Quality Control Act (Water Code § 13000 et seq.)	Required for construction dewatering and for post-construction brine concentrate discharge.
	Water Quality Certification in accordance with Section 401 of the Clean Water Act (33 USC § 1341). Certification based upon finding that discharge will meet water quality standards and that the proposed discharge will comply with water quality standards, defined as numeric and narrative objects in the Basin Plan.	Required for post-construction brine concentrate discharge.
	California Ocean Plan Consistency Determination, including Water Code § 13142.5(b) Determination	Required for the operation of new or expanded desalination facilities using seawater. Determination required by Water Code Section 13142.5, subdivision (b) for evaluation of the best available site, design, technology, and mitigation measures feasible to minimize the intake and mortality of all forms of marine life.
	Groundwater/Site Remediation	Required prior to ocean water desalination facility construction if it is determined that there are contaminated hazardous materials associated with the power plant (soils, electrical generating equipment, etc.) present on the ESGS site.
South Coast Air Quality Management District (SCAQMD)	Permit to Construct	Required for the construction of the ocean water desalination facility and desalinated water conveyance components.
	Permit to Operate	Required for any backup sources of power that could emit air contaminants, such as emergency generators located at the ocean water desalination facility and regional pump station.
Metropolitan Water District of Southern California (MWD)	Encroachment Permit for work within MWD right-of-way and Wheeling Agreement	Required if MWD becomes a Project partner under the Regional Project. West Basin would enter into a Wheeling Agreement for use of MWDs conveyance route to transport the potable water produced from the desalination process to the West Basin service area. This would likely involve an encroachment permit for work within MWD right-of-way.

Agency/Department	Permit/Approval	Required for
Local Agencies		
CEQA Lead Agency (West Basin Municipal Water District Board of Directors)	Certification of Final Environmental Impact Report (CEQA Compliance)	Required for Project implementation.
City of El Segundo ¹	Local Coastal Plan (LCP) amendment in accordance with City of El Segundo Local Coastal Plan. A LCP amendment would require approval from the CCC.	Required for onshore construction of the ocean water desalination facility, which is located within the coastal zone and is under the City of El Segundo LCP jurisdiction. Evaluation of Project consistency with Local Coastal Plan. May be administered by the California Coastal Commission with the City's consent for consolidated permit review.
	Encroachment Permit	Required for desalinated water conveyance components installation
City of El Segundo Fire Department (Certified Unified Program Agency (CUPA))	Hazard Waste Generator Permit (Small Quantity)	Required for the ocean water desalination facility. Pertains to all businesses that generate, handle, treat, or store any amount of hazardous waste.
City of Los Angeles	Encroachment Permit	Required for conveyance line segment in Vista del Mar within the City limits
	Coastal Act compliance	May be required should final design traverse the City's Coastal Zone at the intersection of Vista del Mar and Grand Avenue.
	Connection Agreement	May be required for sanitary sewer system connection depending on the final design solution.
City of Manhattan Beach	Encroachment Permit	May be required for sanitary sewer system connection depending on final design solution.
City of Redondo Beach	Encroachment Permit	Required for desalinated water conveyance components installation.
City of Lawndale	Encroachment Permit	Required for desalinated water conveyance components installation.
City of Hawthorne	Encroachment Permit	Required for desalinated water conveyance components installation.
City of Gardena	Encroachment Permit	Required for desalinated water conveyance components installation.
City of Torrance	Encroachment Permit	Required for desalinated water conveyance components installation.
LA County Department of Public Works	Encroachment Permit	Required for desalinated water conveyance components installation.
L.A. County Sanitation District	Connection Agreement	May be required for sanitary sewer system connection depending on the final design solution.
L.A. County Parks	Encroachment Permit	May be required for temporary ESGS seawall work along Marvin Braude Bike Trail.
County of Los Angeles (Del Aire or El Camino Village)	Encroachment Permit	Required for desalinated water conveyance components installation.

3. Project Description

Agency/Department	Permit/Approval	Required for
Other		
Southern California Edison (SCE)	Grid Connection	Required for ocean water desalination facility utility connections.
NRG Energy, Inc.	Real Estate Lease/Purchase	<p>Project would require approvals to access the site for environmental and engineering investigations (e.g. access for general reconnaissance, geotechnical investigation, hazardous materials reconnaissance, etc.)</p> <p>Lease agreement required for desalination facility construction and operation on ESGS property.</p>

NOTES:

¹ Note that California Government Code Section 53091(d) states that “[b]uilding ordinances of a county or city shall not apply to the location or construction of facilities for the production, generation, storage, treatment, or transmission of water, wastewater, or electrical energy by a local agency.” Furthermore, Section 53091(e) states that “[z]oning ordinances of a county or city shall not apply to the location or construction of facilities for the production, generation, storage, treatment, or transmission of water” However, West Basin intends to make every effort to comply with all applicable building and zoning ordinances stipulated under the City of El Segundo Municipal Code in the construction and operation of the Ocean Water Desalination Project.

* Permits, approvals, and regulatory requirements identified herein are partially based upon Malcolm Pirnie/Arcadis, Ocean Water Desalination Program Master Plan Volume I, Table 2-8 (Anticipated Permits, Timeline, and Estimated Cost), January 2013.

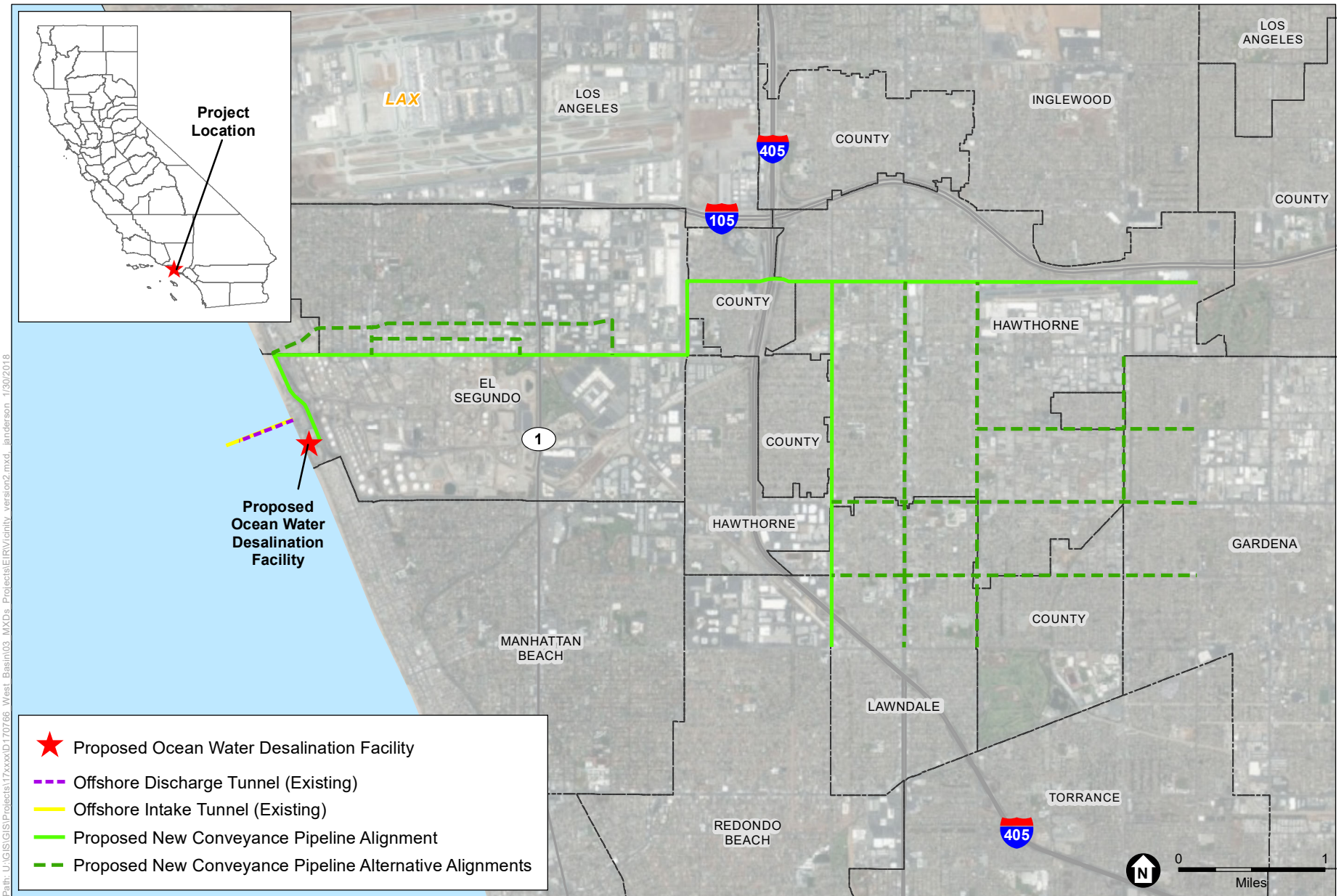

SOURCE: ESRI

West Basin Ocean Water Desalination Project

Figure 3-1
Vicinity Map

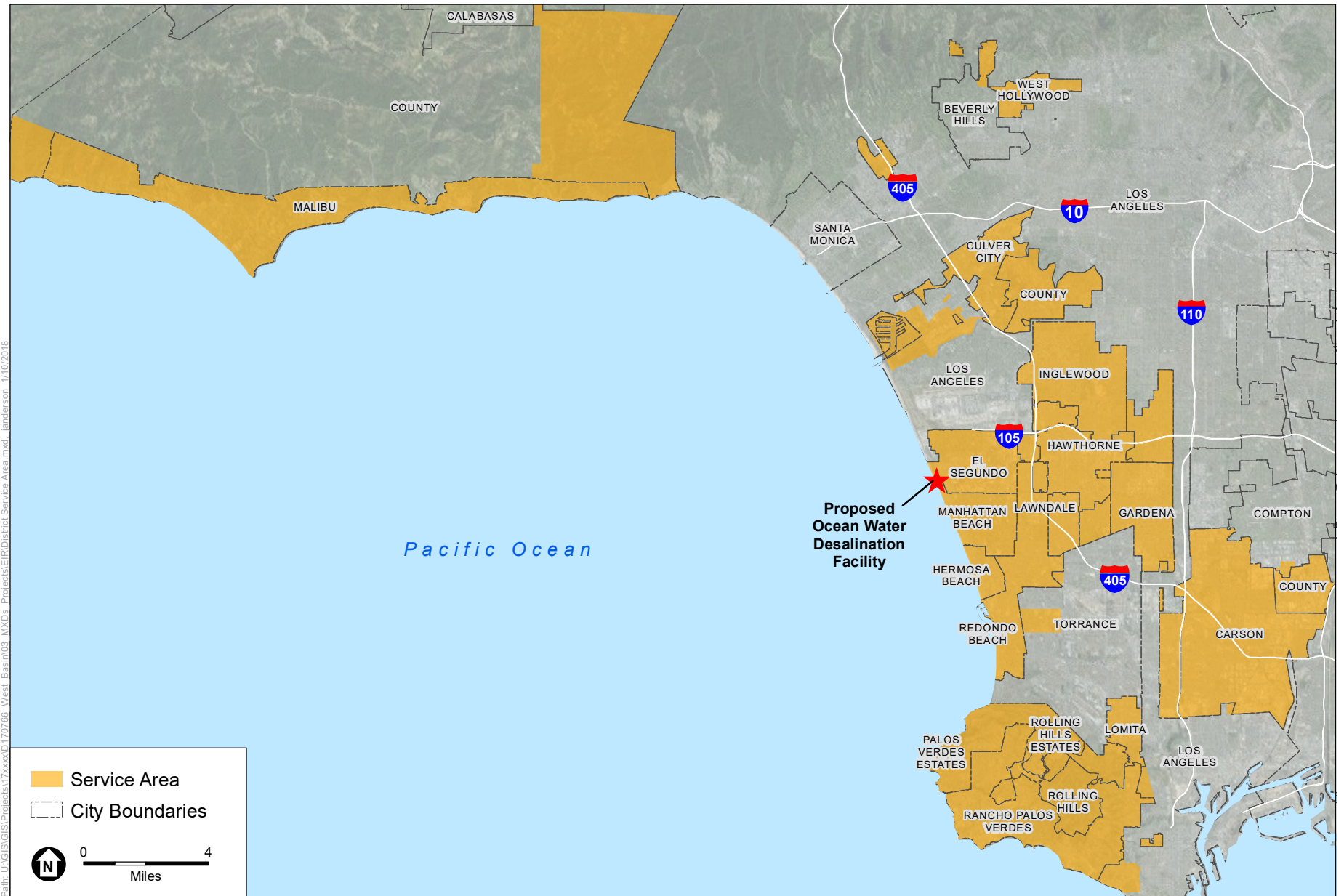

Path: U:\GIS\GIS\Projects\17xxxx\170766_West_Basin\03_MXDs\Projects\ER\District Service Area.mxd, landerson, 1/10/2018

SOURCE:ESRI; Los Angeles County

West Basin Ocean Water Desalination Project

Figure 3-2
District Service Area





SOURCE: Michael Baker International, 2016

West Basin Ocean Water Desalination Project

Figure 3-3
Existing ESGS Site





SOURCE: ESRI

Chevron Marine Terminal 2010 EIR

Figure 3-4
Existing 12-foot Diameter Intake and Discharge Tunnels

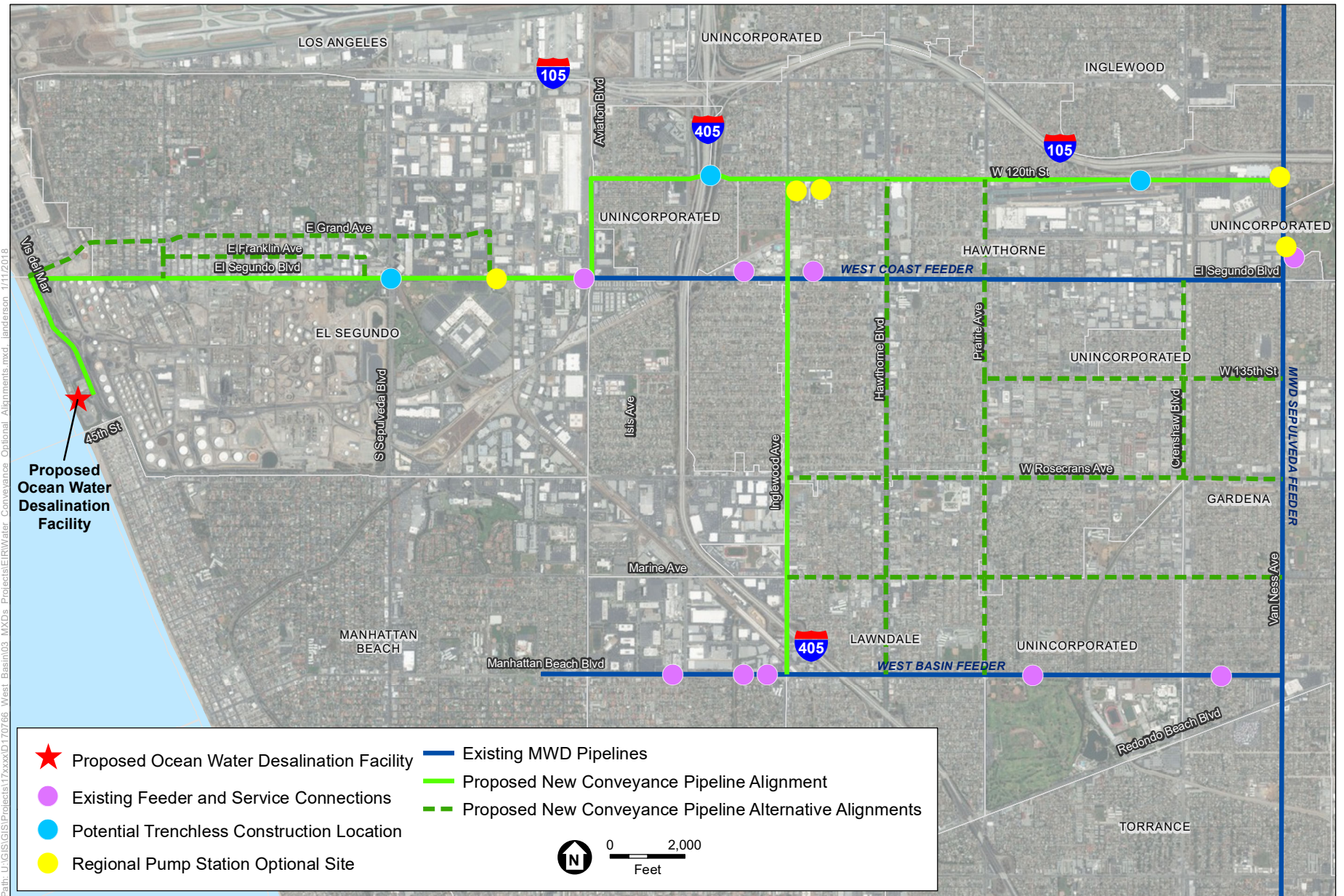

SOURCE: ESRI

West Basin Ocean Water Desalination Project
Figure 3-5
 Desalinated Water Conveyance Optional Alignments



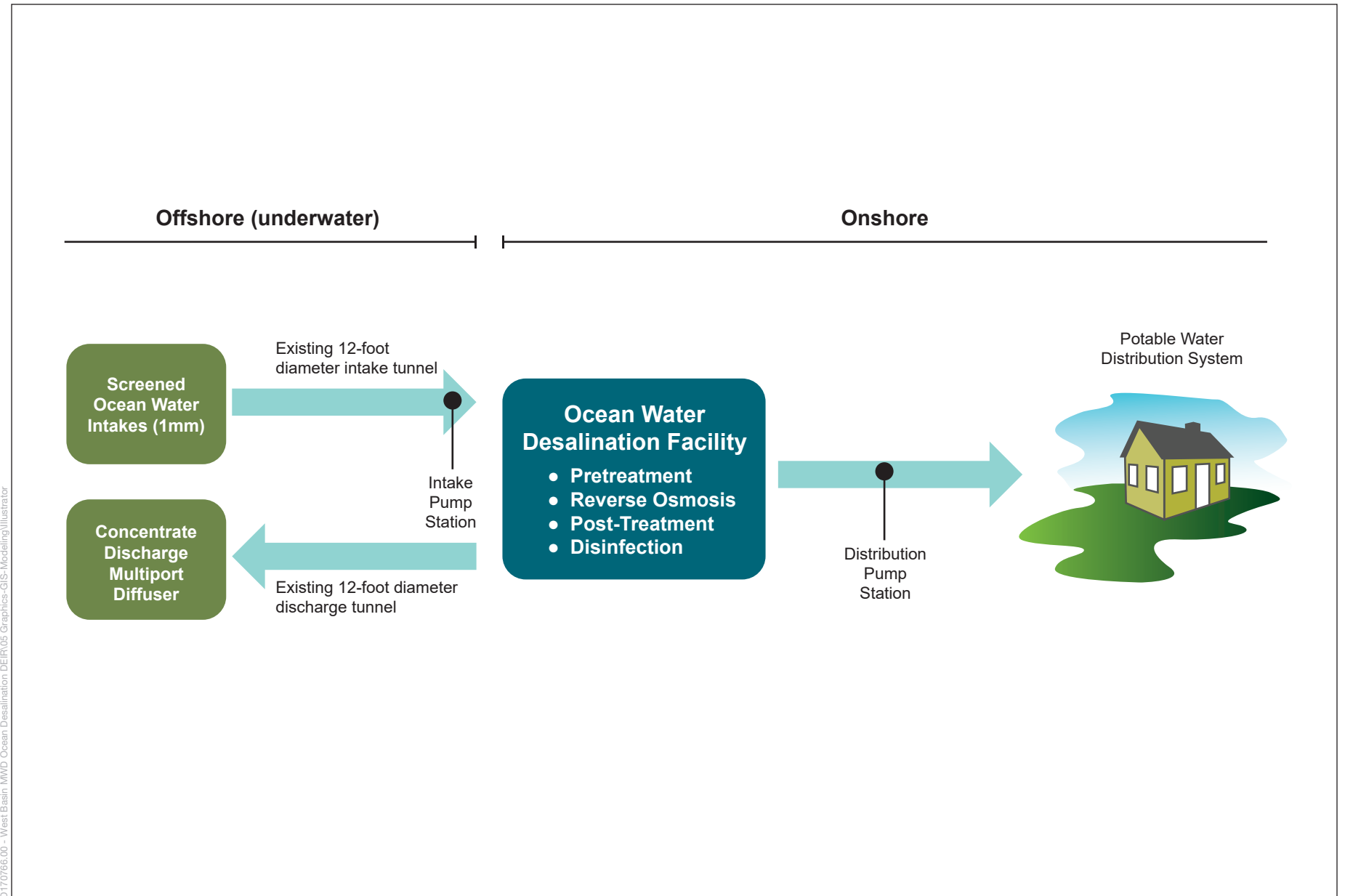

D:\70766.00 - West Basin MWD Ocean Desalination DEIR\05 Graphics-GIS-Modeling\Illustrator

SOURCE: ESA, 2017

West Basin Ocean Water Desalination Project

Figure 3-6
Proposed Project Schematic



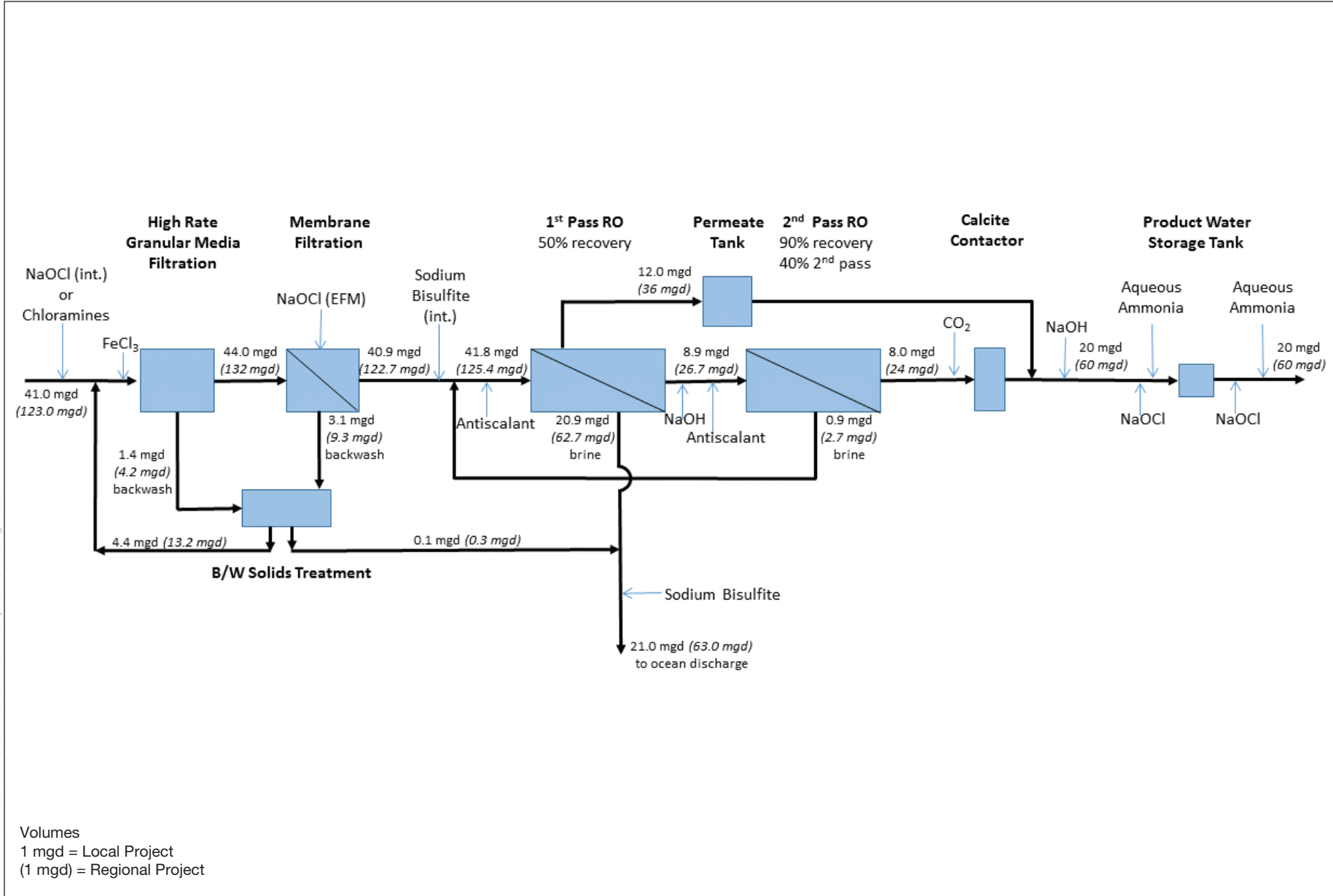

SOURCE: Michael Baker International, 2016

West Basin Ocean Water Desalination Project

Figure 3-7
 Flow Diagram including High Rate Granular Media Filtration Pretreatment



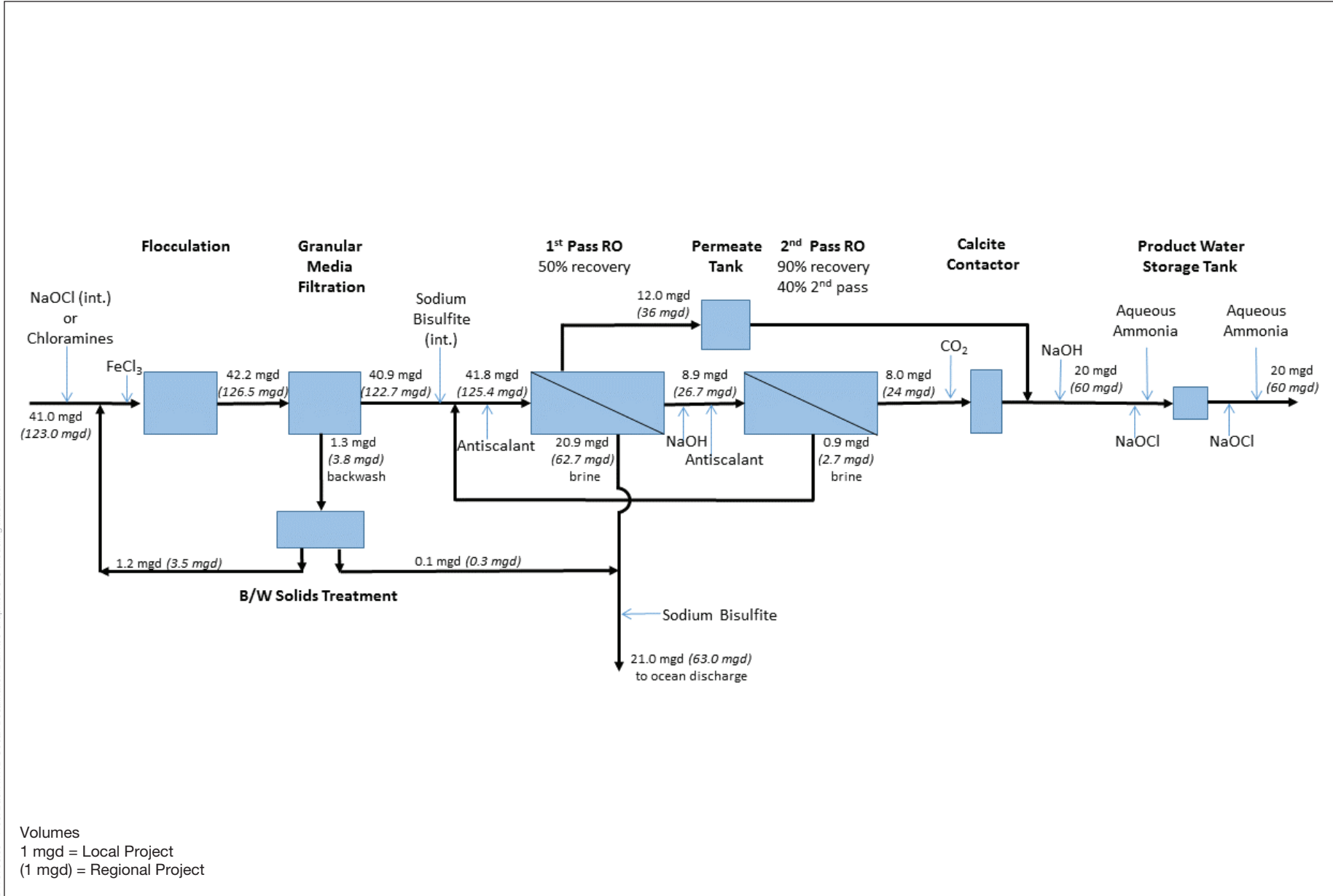

SOURCE: Michael Baker International, 2016

West Basin Ocean Water Desalination Project

Figure 3-8

Flow Diagram including GMF Pretreatment



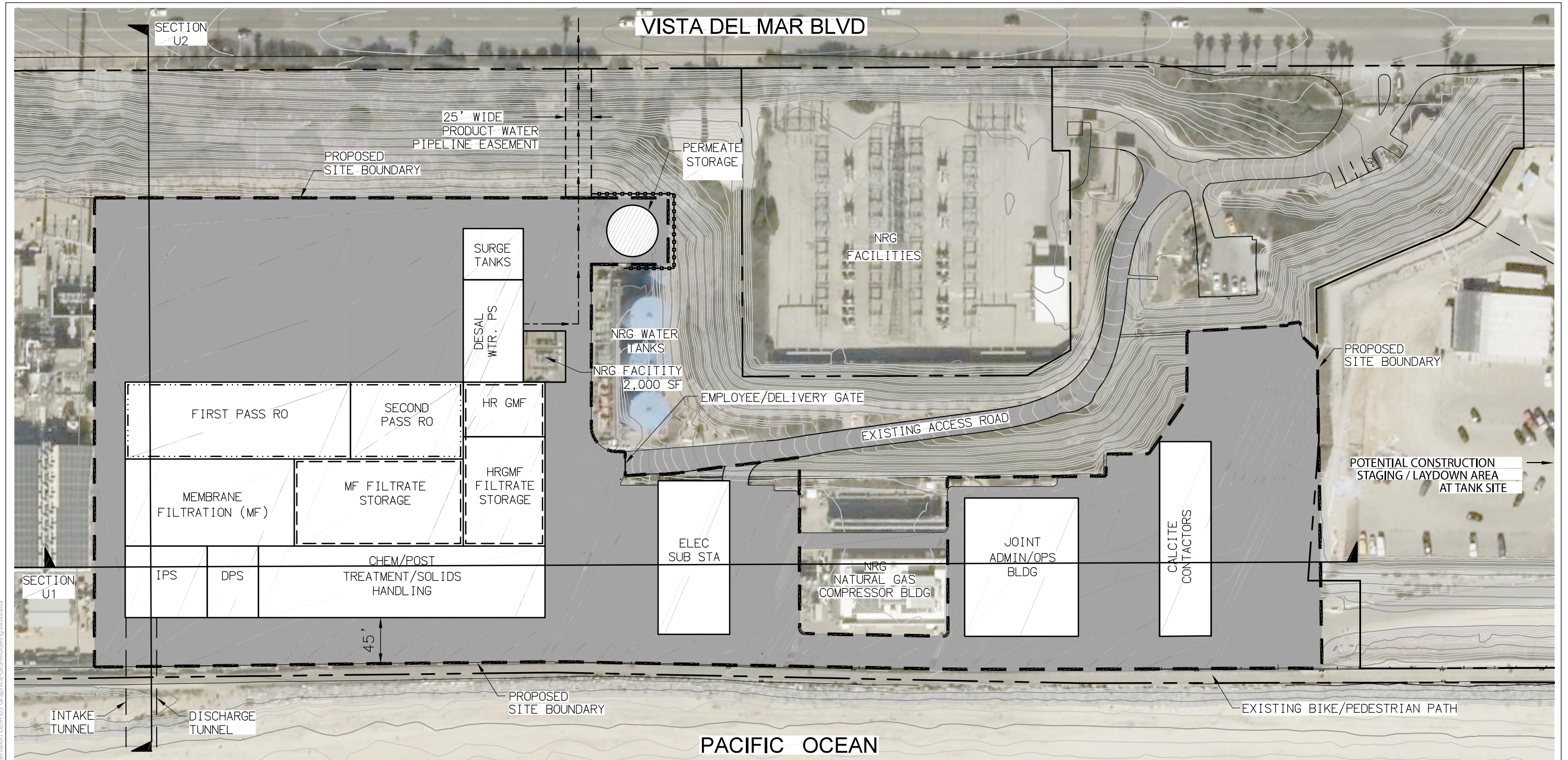

D:\170766.00 - West Basin MWD Ocean Desalination\DEIR\05 Graphics-GIS-Modeling\Illustrator

SOURCE: Michael Baker International, 2016

West Basin Ocean Water Desalination Project

Figure 3-9

20 MGD Ocean Water Desalination Facility Layout - ESGS North Site



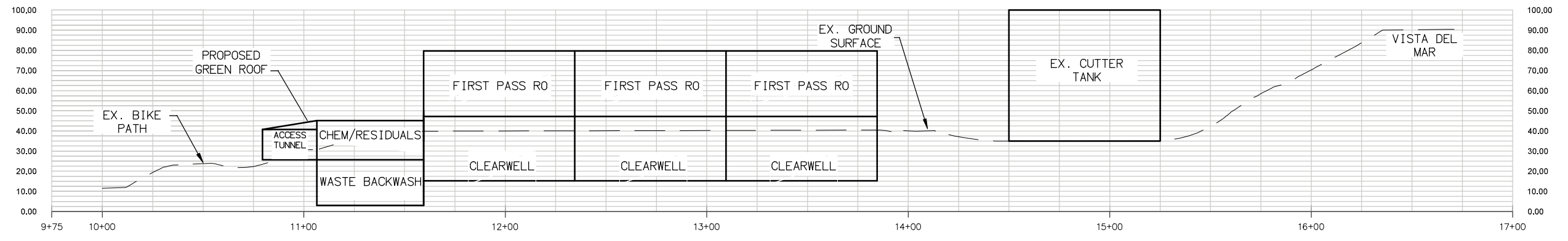

60 MGD REGIONAL PROJECT

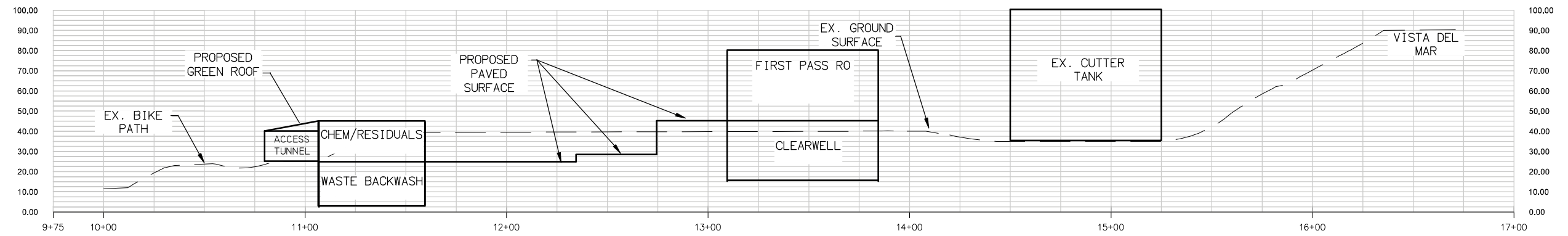

20 MGD LOCAL PROJECT

D:\170766.00 - West Basin MWD Ocean Desalination DEIR\05 Graphics-GIS-Modeling\Illustrator

SOURCE: Michael Baker International, 2016

West Basin Ocean Water Desalination Project

Figure 3-11

Section TS1 - ESGS South Site

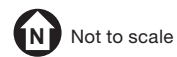

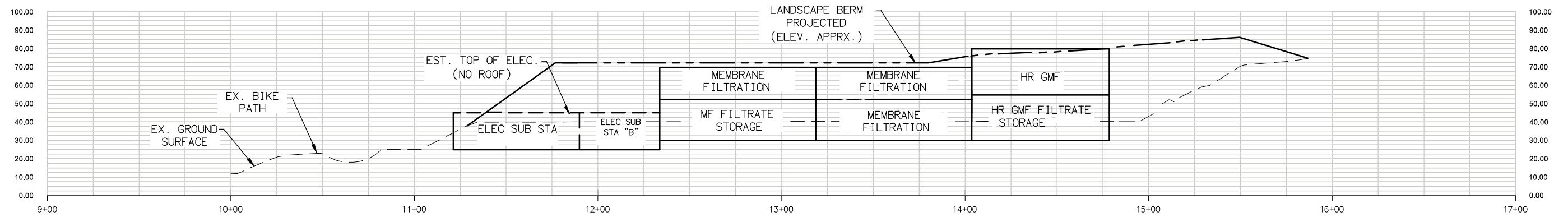

60 MGD REGIONAL PROJECT

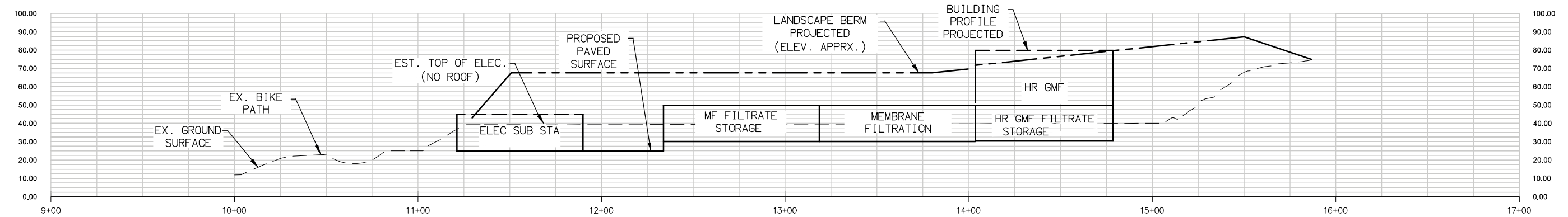

20 MGD LOCAL PROJECT

D:\170766.00 - West Basin MWD Ocean Desalination DEIR\05 Graphics-GIS-Modeling\Illustrator

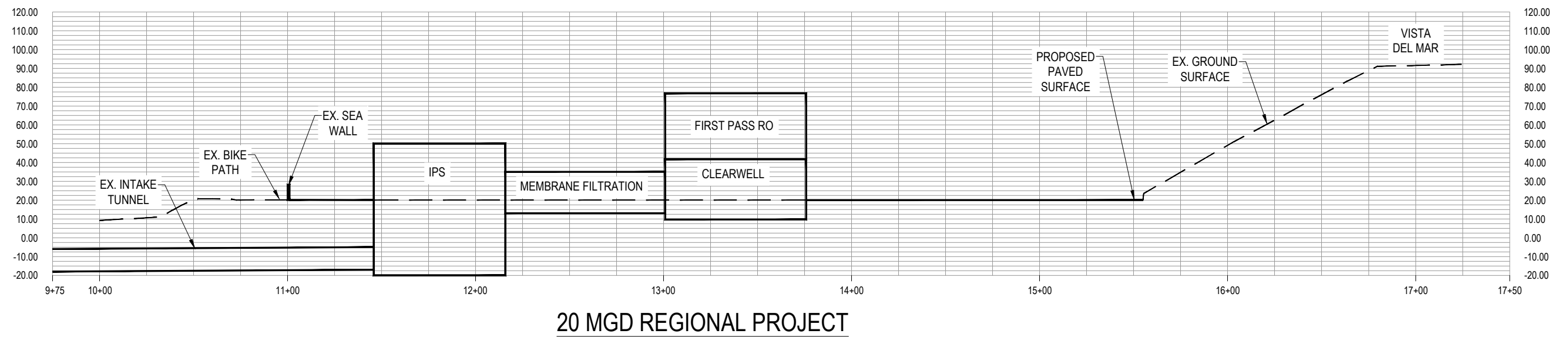
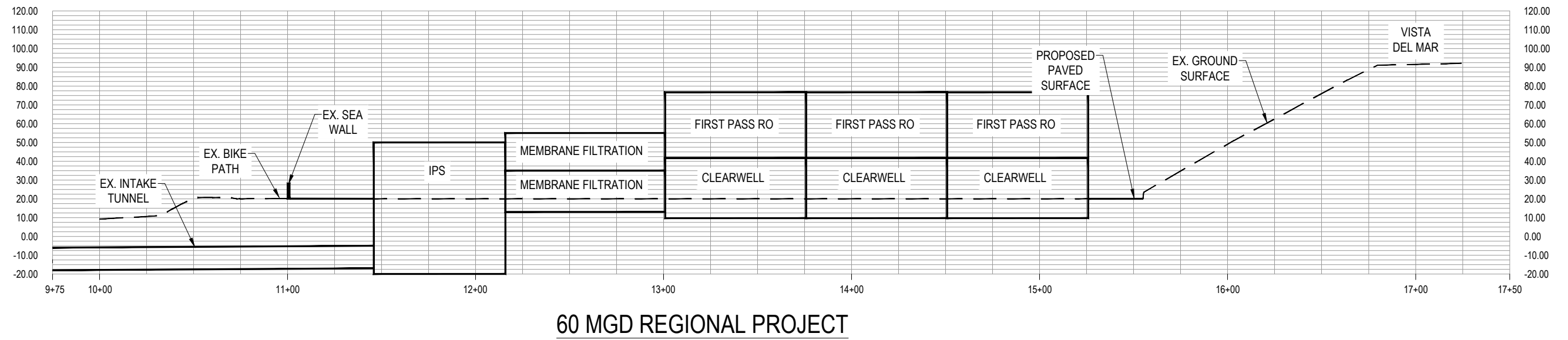

D:\170766.00 - West Basin MWD Ocean Desalination DEIR\05 Graphics-GIS-Modeling\Illustrator

SOURCE: GHD 2017

West Basin Ocean Water Desalination Project

Figure 3-13
Section U1 - ESGS North Site



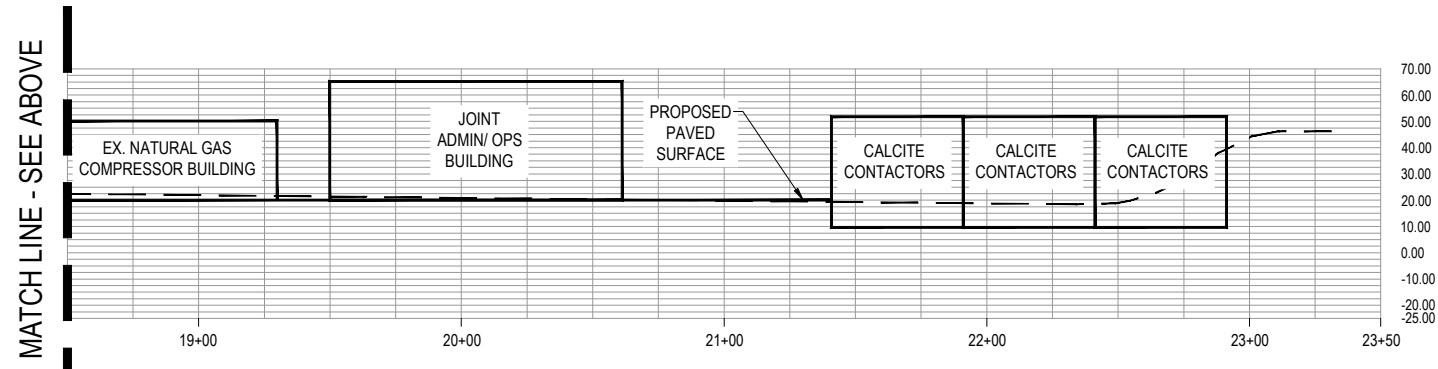
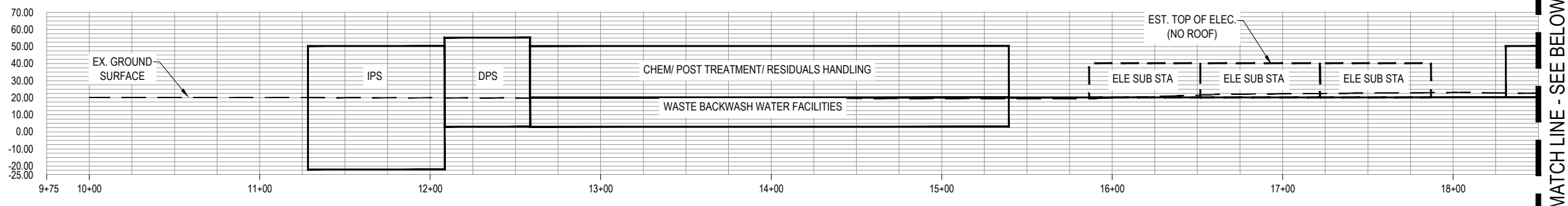

60 MGD REGIONAL PROJECT

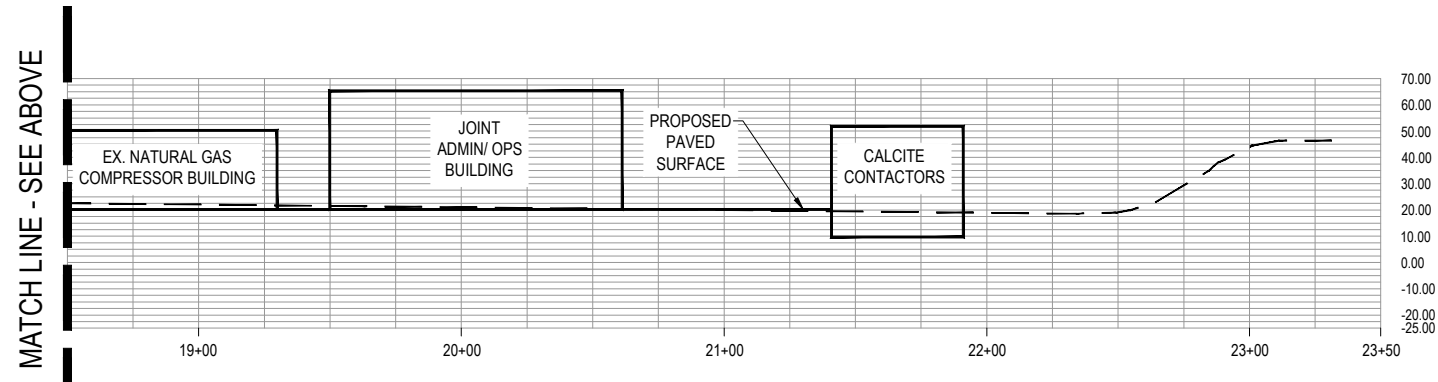
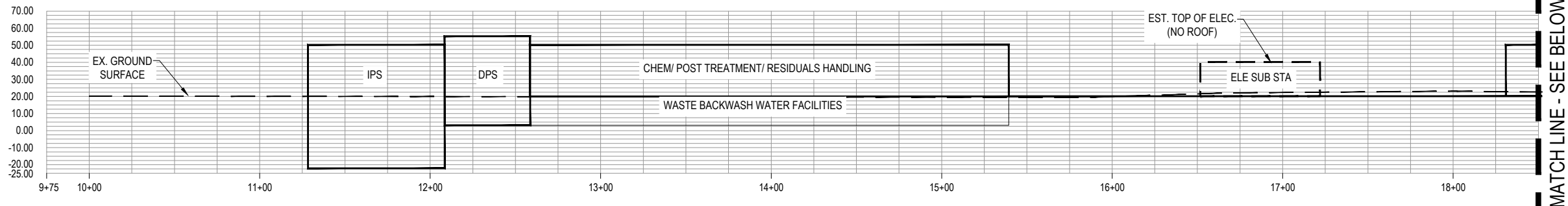

20 MGD REGIONAL PROJECT

D:\170766.00 - West Basin MWD Ocean Desalination DEIR\05 Graphics-GIS-Modeling\Illustrator

SOURCE: GHD 2017

West Basin Ocean Water Desalination Project

Figure 3-14
Section U2 - ESGS North Site



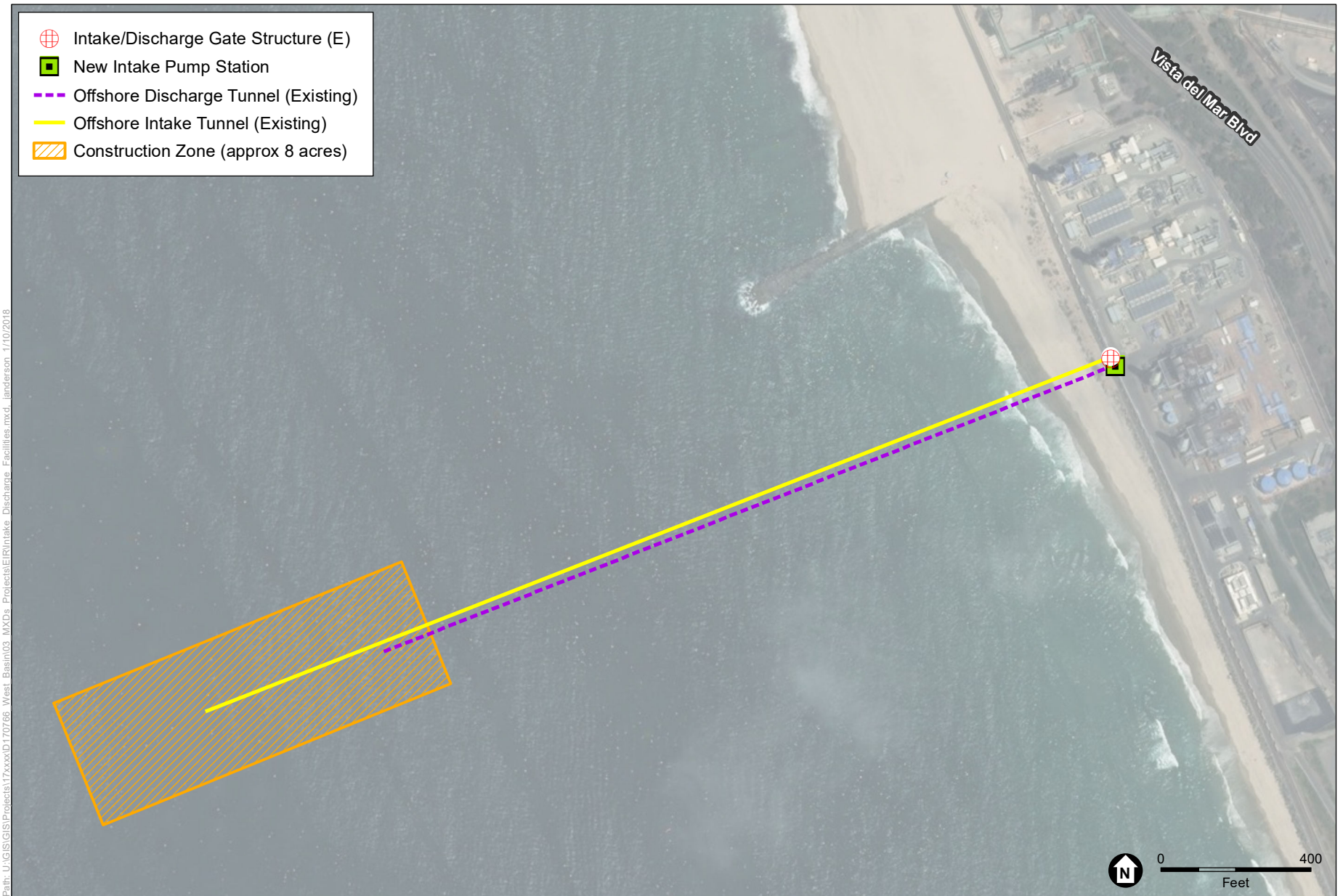

SOURCE: ESRI

West Basin Ocean Water Desalination Project

Figure 3-15

Intake and Discharge Facilities



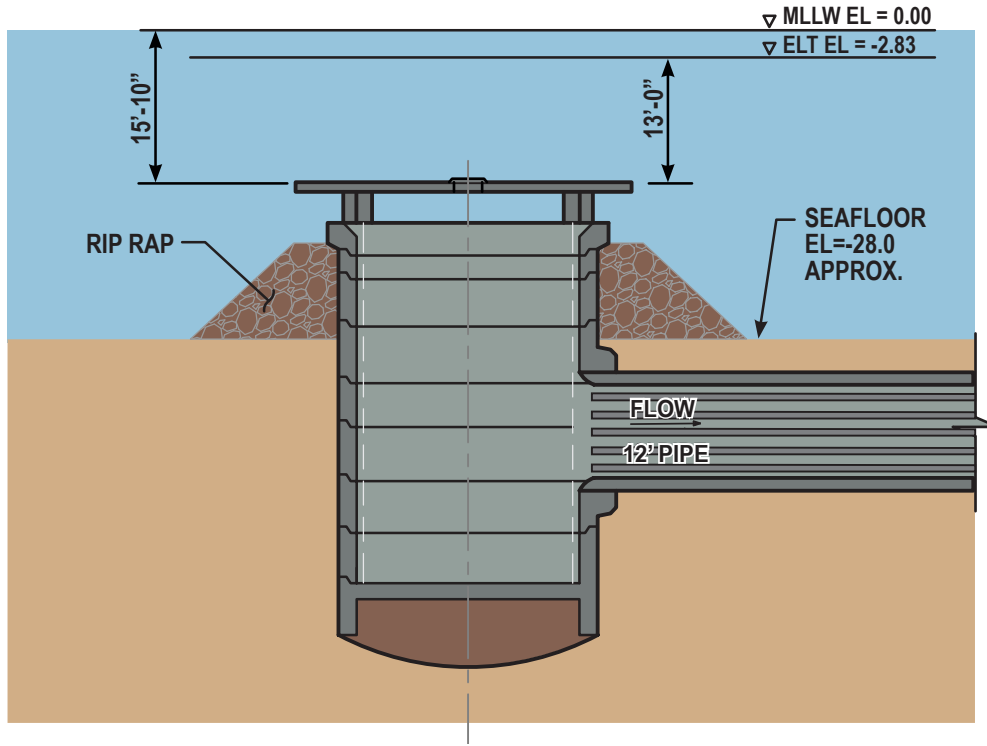
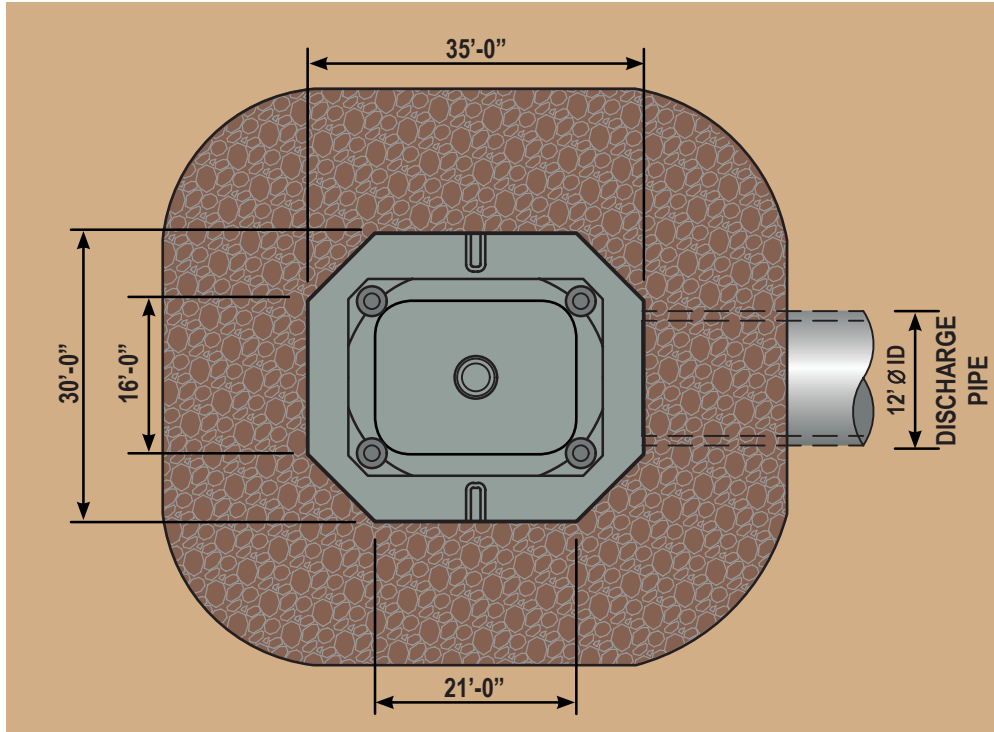

D:\70766.00 - West Basin MWD Ocean Desalination DEIR\05 Graphics-GIS-Modeling\Illustrator

SOURCE: GHD 2017

West Basin Ocean Water Desalination Project

Figure 3-16a
Existing Intake Structure



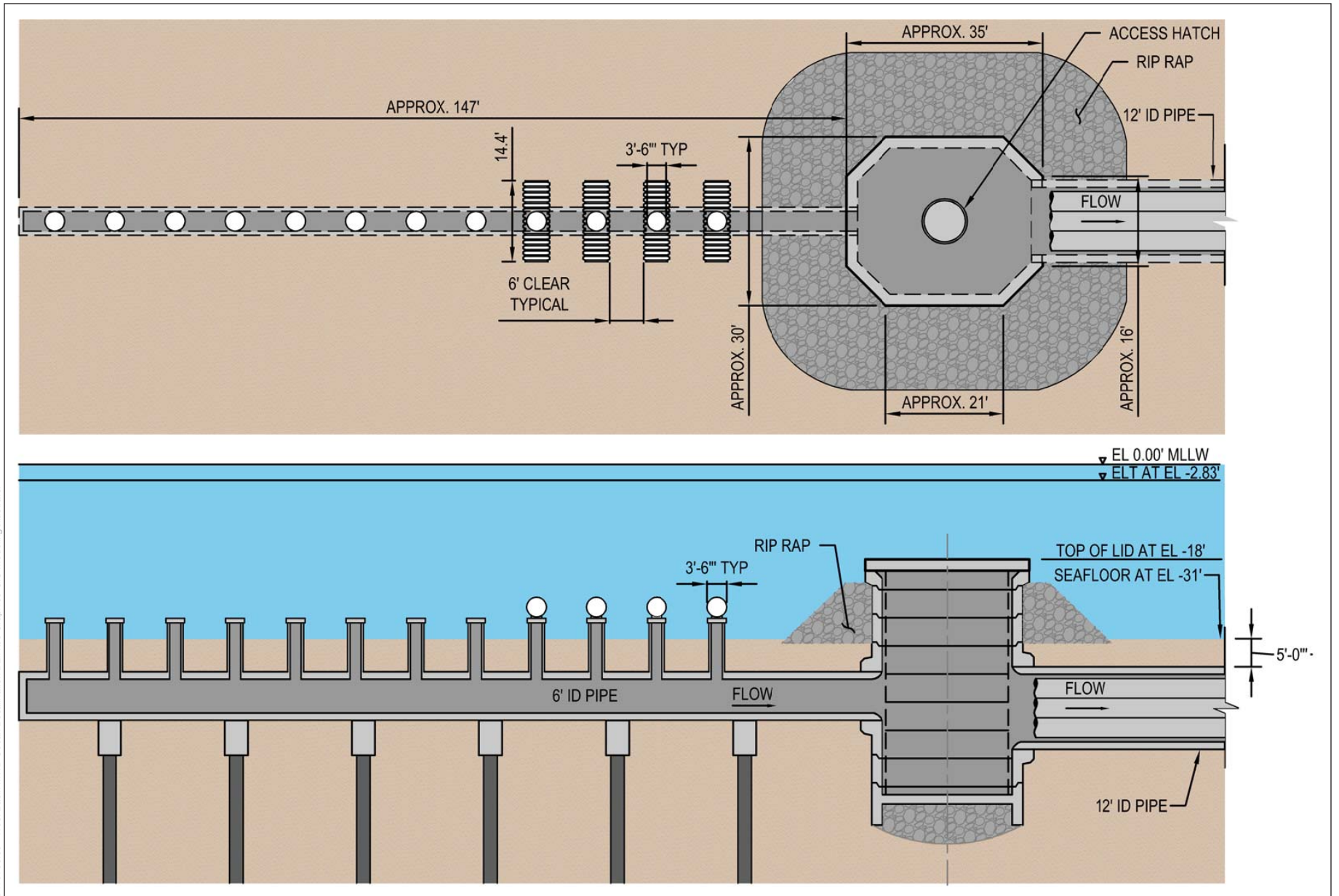

D:\70766.00 - West Basin MWD Ocean Desalination DEIR\05 Graphics-GIS-Modeling\Illustrator

SOURCE: GHD 2017

West Basin Ocean Water Desalination Project

Figure 3-16b
Proposed Intake Structure
(Local Project)



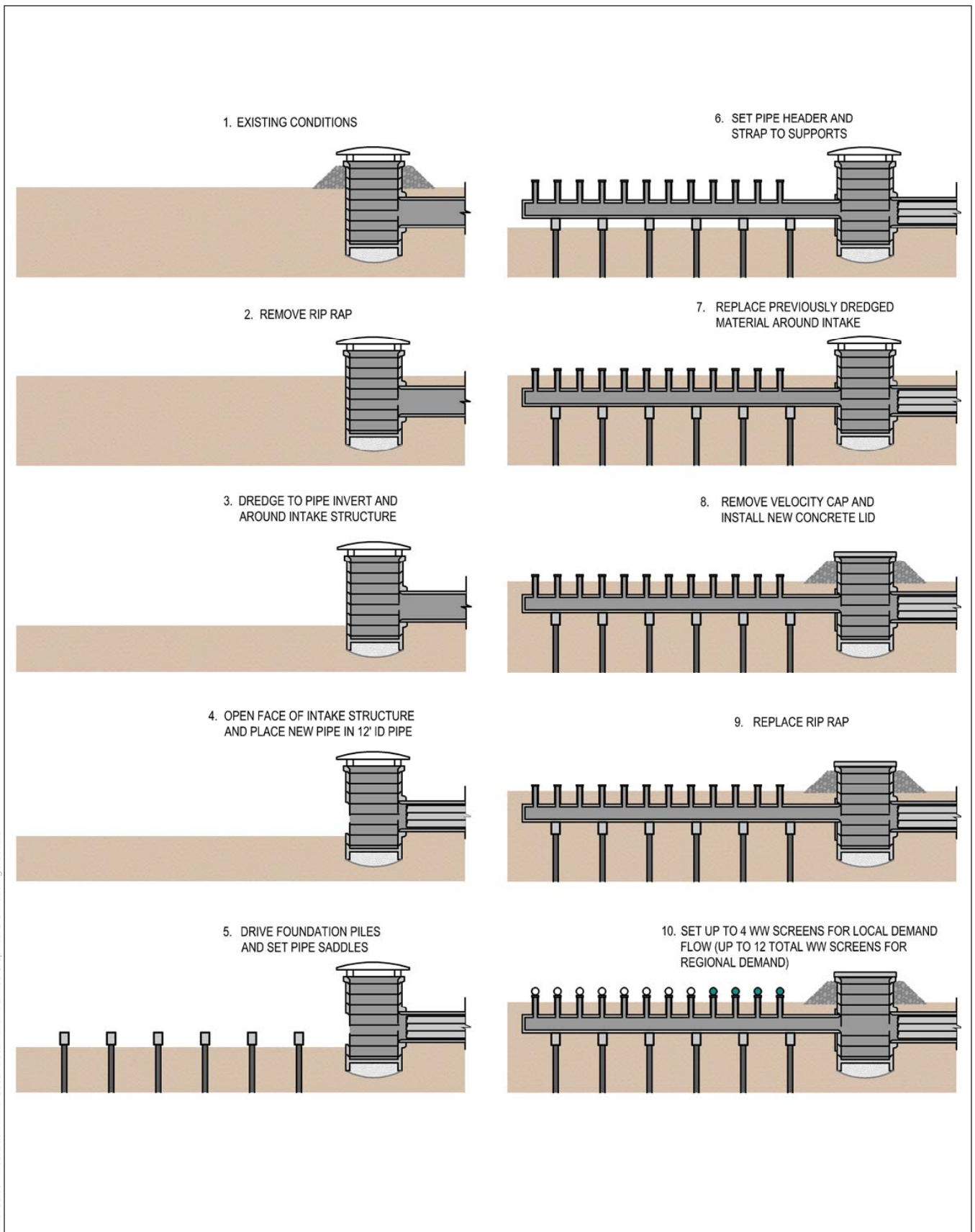

D:\70766.00 - West Basin MWD Ocean Desalination DEIR\05 Graphics-GIS-Modeling\Illustrator

SOURCE: GHD 2017

West Basin Ocean Water Desalination Project

Figure 3-16c

Intake Structure Installation



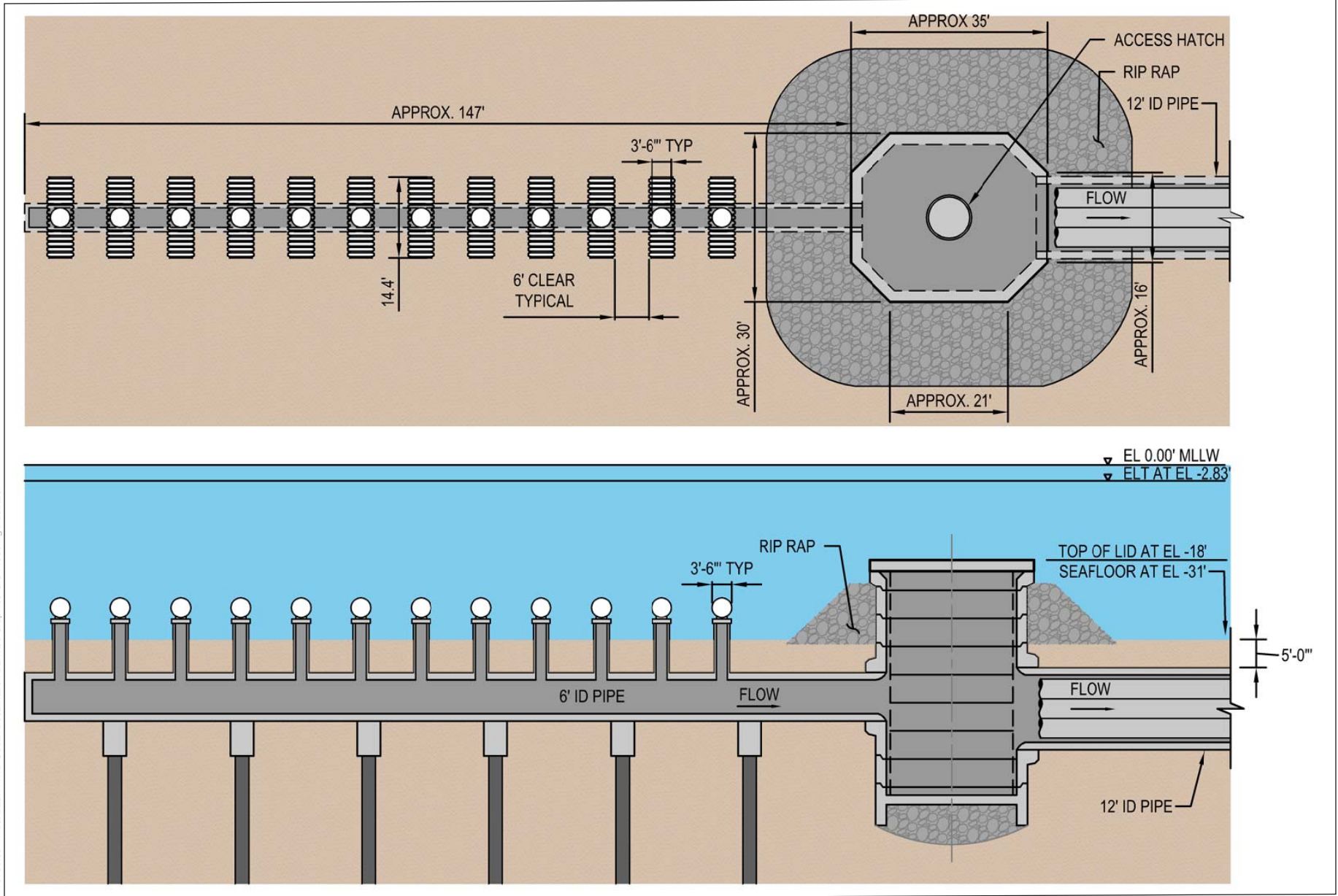

D170766.00 - West Basin MWD Ocean Desalination DEIR05 Graphics-GIS-Modeling/illustrator

SOURCE: GHD 2017

West Basin Ocean Water Desalination Project

Figure 3-16d
Proposed Intake Structure
(Regional Project)



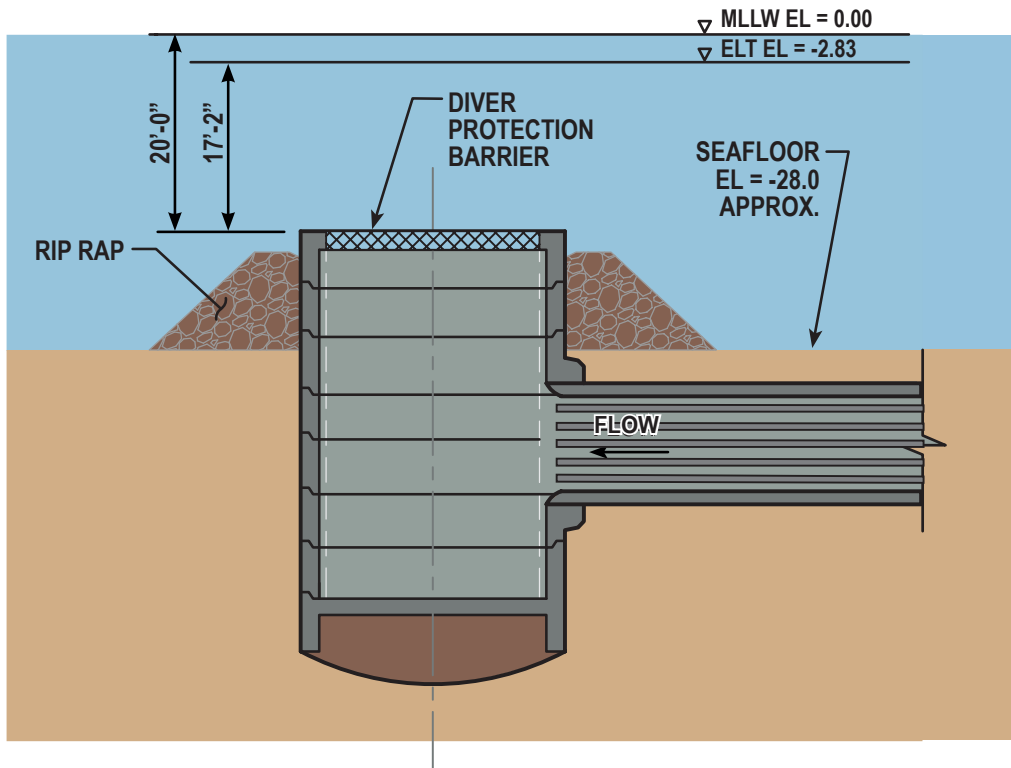
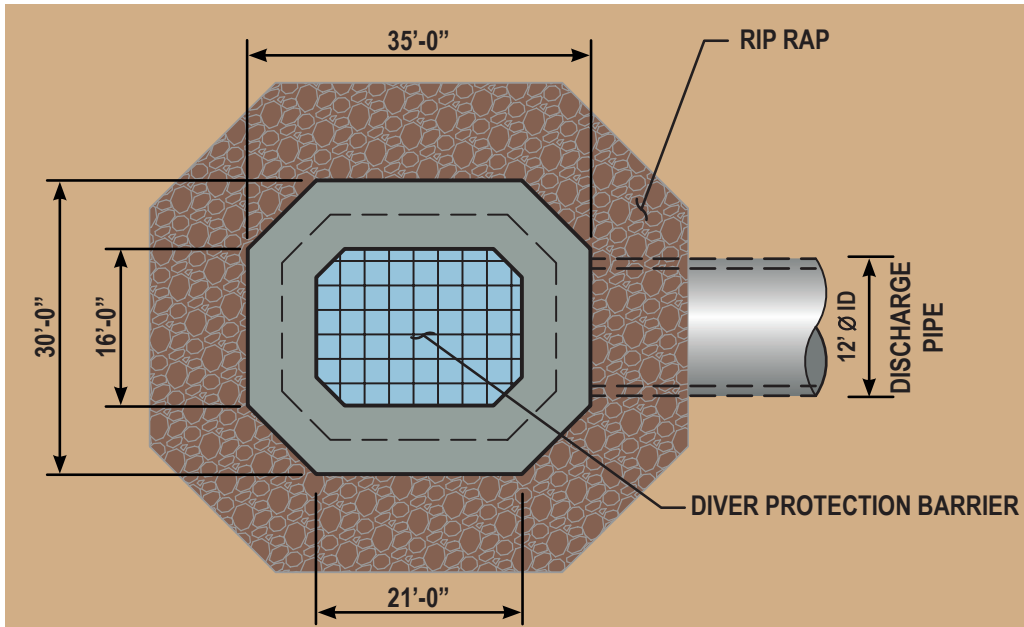

D:\70766.00 - West Basin MWD Ocean Desalination DEIR\05 Graphics-GIS-Modeling\Illustrator

SOURCE: GHD 2017

West Basin Ocean Water Desalination Project

Figure 3-18a
Existing Discharge Structure



EXISTING CONDITION

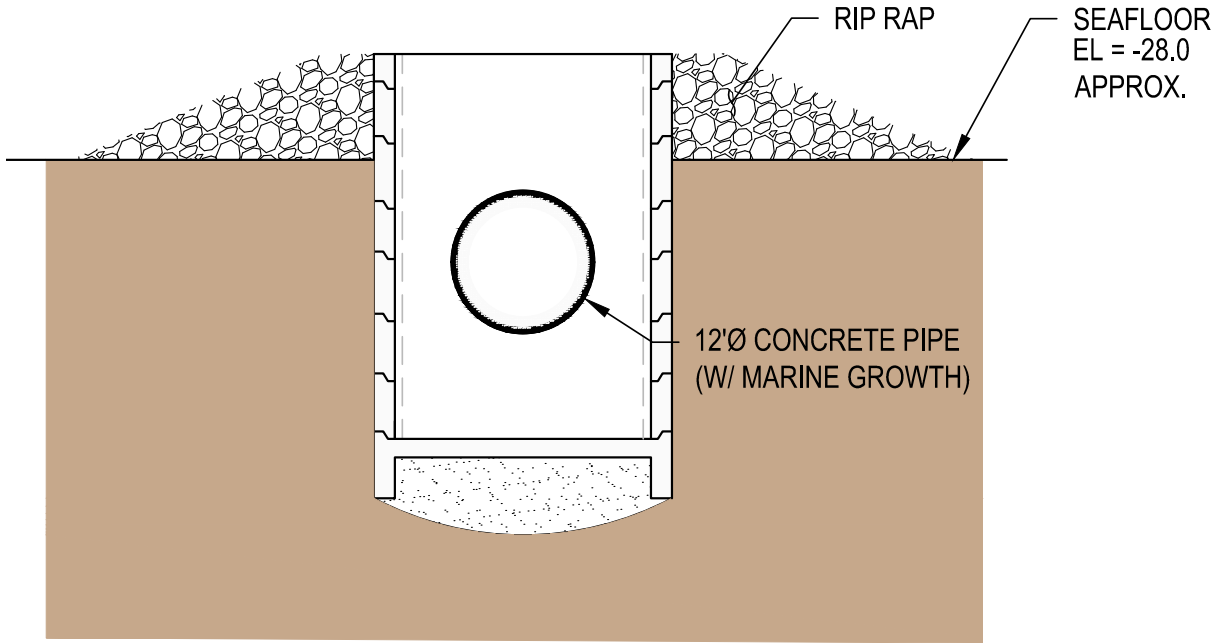

PROPOSED CONDITION

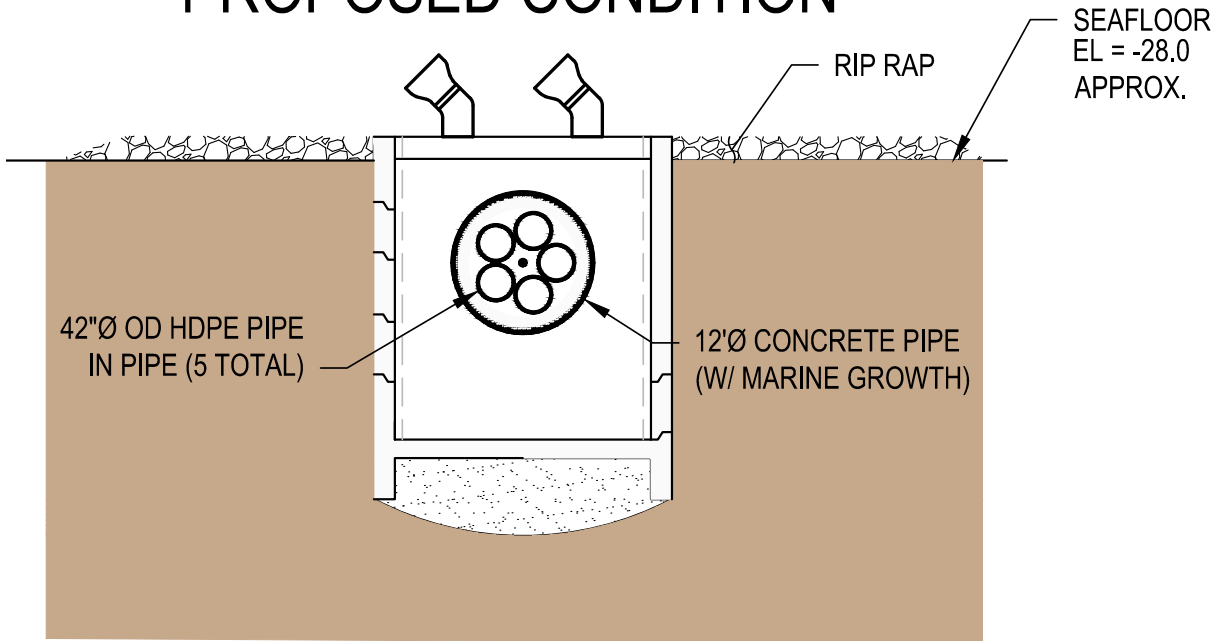

D:\770766.00 - West Basin MWD Ocean Desalination DEIR\05 Graphics-GIS-Modeling\Illustrator

SOURCE: GHD 2017

West Basin Ocean Water Desalination Project

Figure 3-18b

Discharge Cross Section



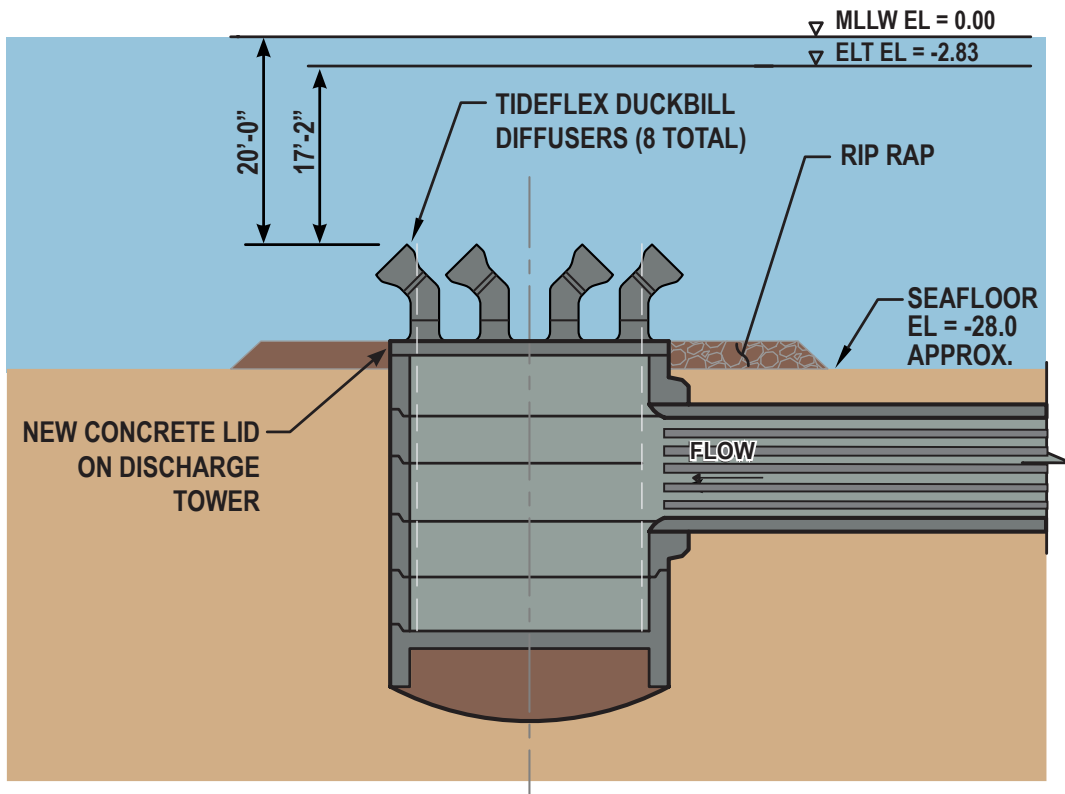
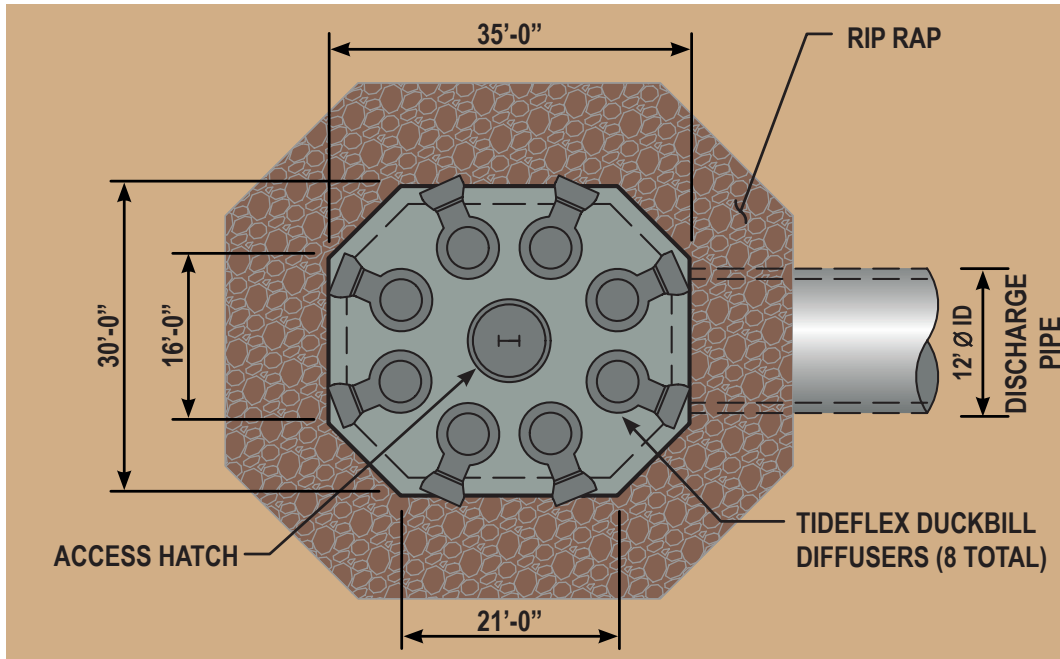

D:\70766.00 - West Basin MWD Ocean Desalination DEIR\05 Graphics-GIS-Modeling\Illustrator

SOURCE: GHD 2017

West Basin Ocean Water Desalination Project

Figure 3-18c
Proposed Discharge Structure
(Local Project)



1. EXISTING CONDITIONS

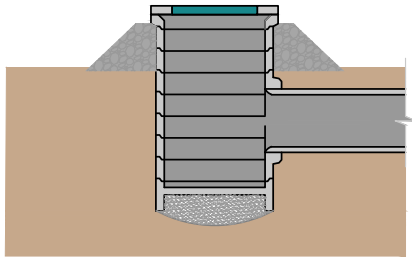

5. SEAL FACE OF DISCHARGE STRUCTURE AND REPLACE PREVIOUSLY DREDGED MATERIAL

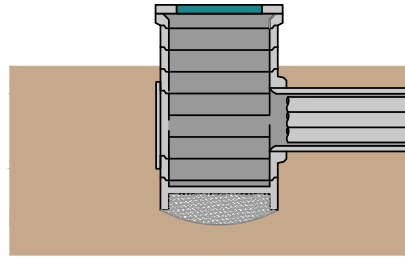

2. REMOVE RIP RAP

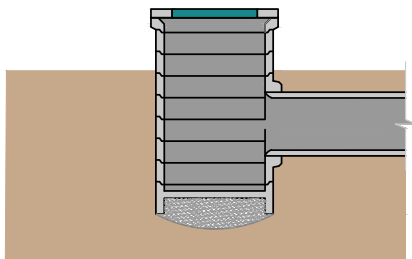

6. SAWCUT TOP OF DISCHARGE STRUCTURE

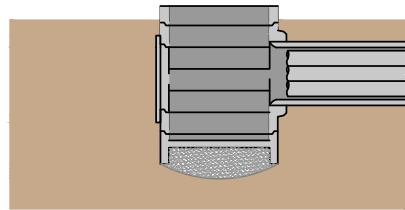

3. DREDGE TO PIPE INVERT AND AROUND DISCHARGE STRUCTURE

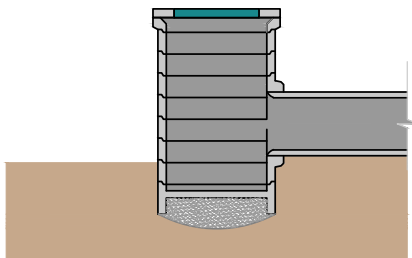

7. INSTALL NEW CONCRETE LID AND REPLACE RIP RAP

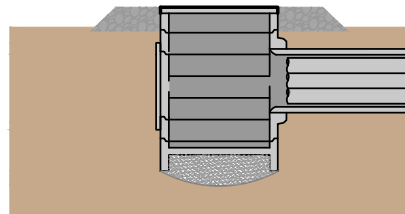

4. OPEN FACE OF DISCHARGE STRUCTURE AND PLACE NEW PIPE IN 12' ID PIPE

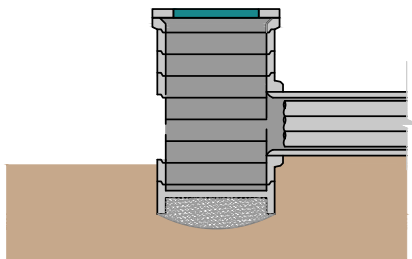

8. INSTALL DIFFUSERS

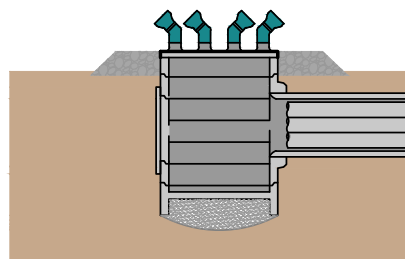

D:\70766.00 - West Basin MWD Ocean Desalination DEIR\05 Graphics-GIS-Modeling\Illustrator

SOURCE: GHD 2017

West Basin Ocean Water Desalination Project

Figure 3-18d

Discharge Structure Installation



This page intentionally left blank

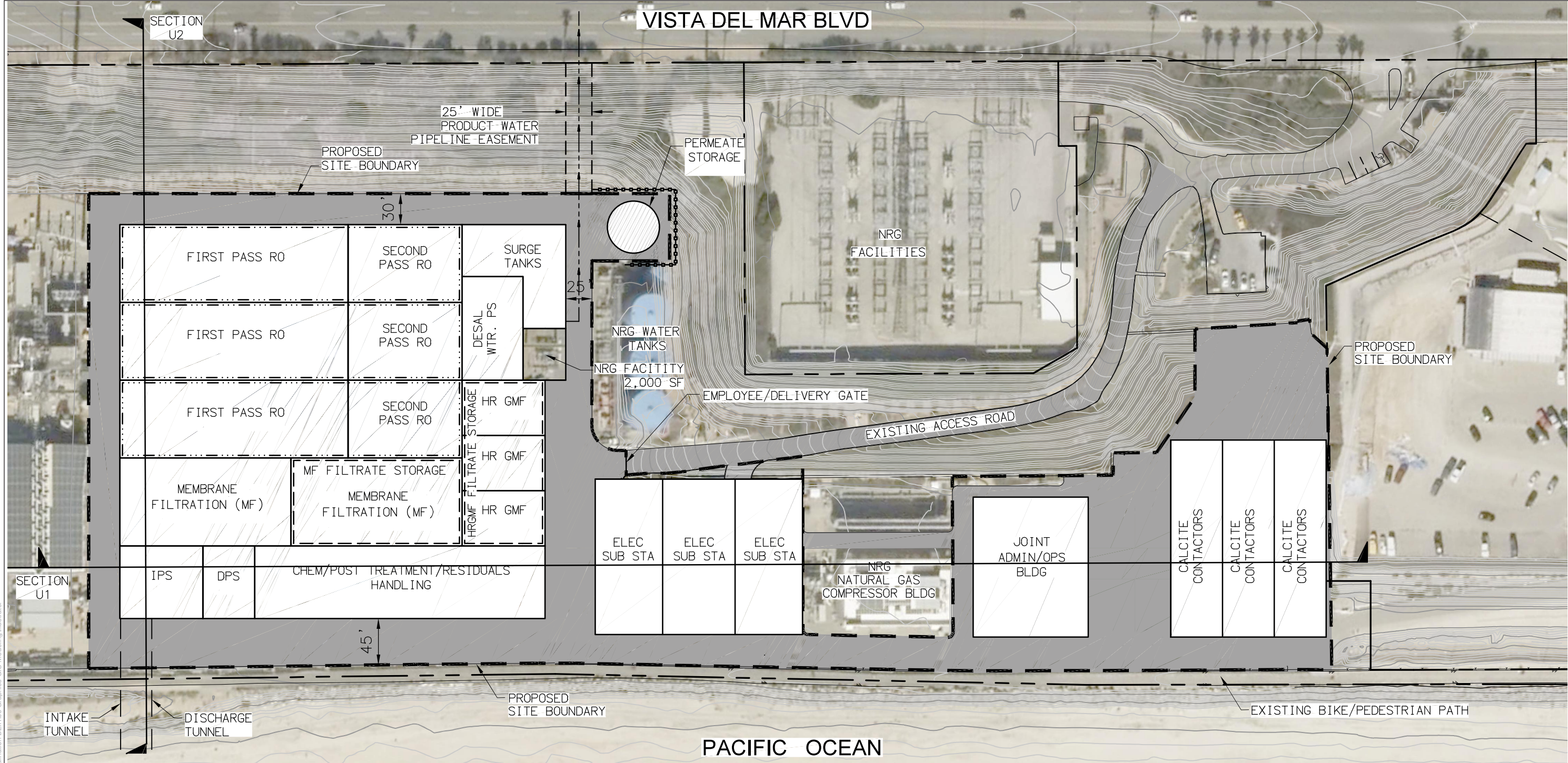

- FILTRATE STORAGE (BURIED) -----
- PRODUCT WATER STORAGE WELL BELOW RO BUILDING - - - - -
- RETAINING WALL - - - - -
- CONVEYANCE PIPELINE - - - - -



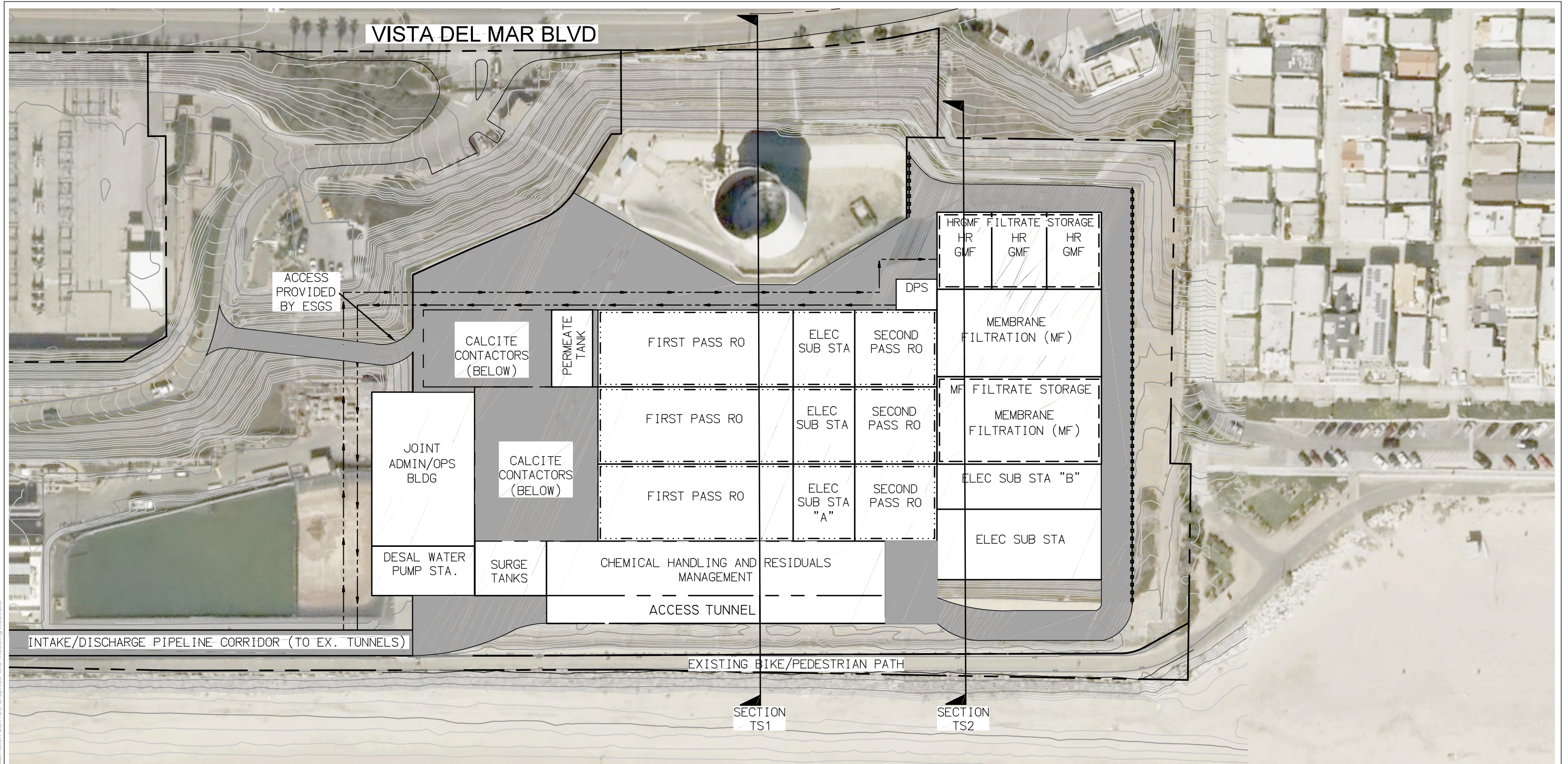

- FILTRATE STORAGE BELOW MF — — — — —
- PRODUCT WATER STORAGE WELL BELOW RO/ELEC BUILDING - - - - -
- UNDERGROUND FACILITY — — — — —
- RETAINING WALL — — — — —
- CONVEYANCE PIPELINE — — — — —



D:\170766.00 - West Basin MWD Ocean Desalination DEIR\05 Graphics-GIS-Modeling\Illustrator

SOURCE: Michael Baker International, 2016

West Basin Ocean Water Desalination Project

Figure 3-20
60 MGD Ocean Water Desalination Facility Layout - ESGS South Site



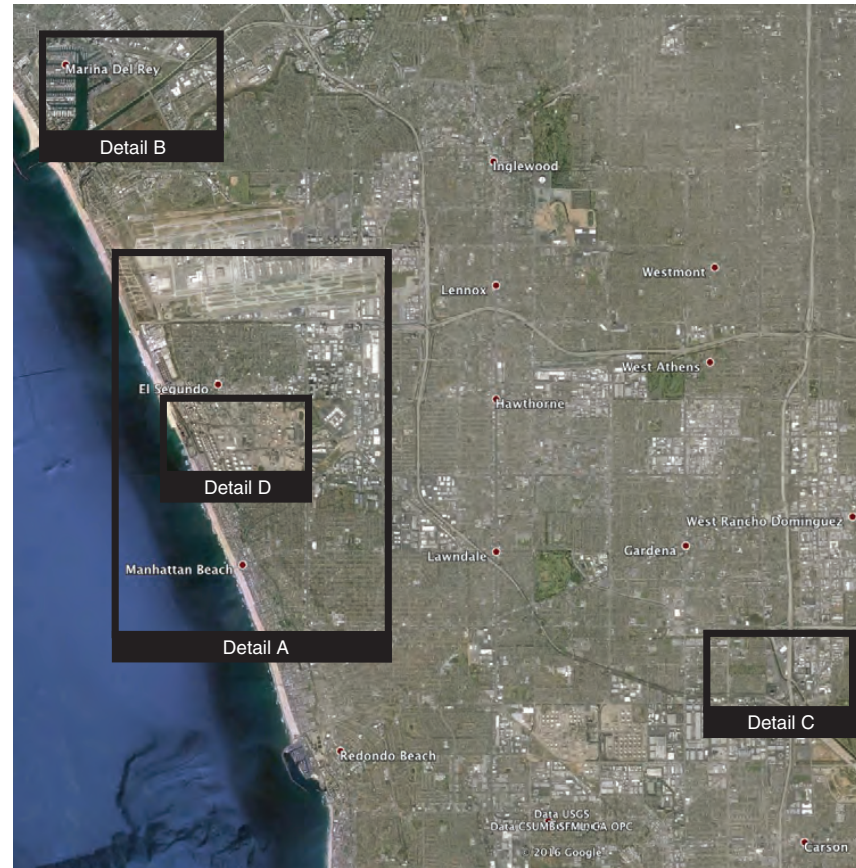

Off-Site Laydown and Parking Areas Location Map

Potential Laydown and Parking Areas

- | | |
|----------------------------------|---------------------------|
| 1 Kramer | 7 Grand Avenue |
| 2 Fedex | 8 Chevron Marine Terminal |
| 3 LAX-Pershing | 9 Power Plant Site |
| 4 Marina del Rey Boat Launch | 10 Chevron |
| 5 Scattergood Generating Station | 11 190th Street |
| 6 Hyperion | |

- El Segundo Power Facility Modification Laydown / Parking Area
- Ocean Water Desalination Project Additional Laydown / Parking Area

Note: Offsite staging areas are preliminary, subject to change during final design and construction.
 Source: California Energy Commission, Final Staff Assessment Combined Parts A & B - El Segundo Power Facility Modification to the El Segundo Energy Center, August 27, 2015.
 Aerial photo source: Google



Detail A - Areas 1 through 9 (excluding 4); Refer to Exhibit 3-4, Desalinated Water Conveyance Optional Alignments

Legend

- ★ Proposed Ocean Water Desalination Facility
 - Desalination Water Pipeline
 - WC Feeder Service Connector
 - WB Feeder Connector
 - Regional Pipeline
 - City Boundaries
 - Potential Trenchless Construction Location
 - 1-5 Regional Pump Station Alternative Location
- Note: Potential trenchless construction locations would assume approx. 500 LF +/- of Jack & Bore

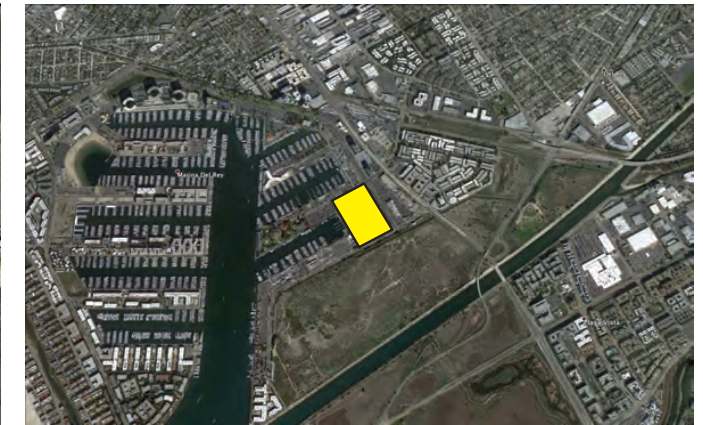

Detail B - Area 4

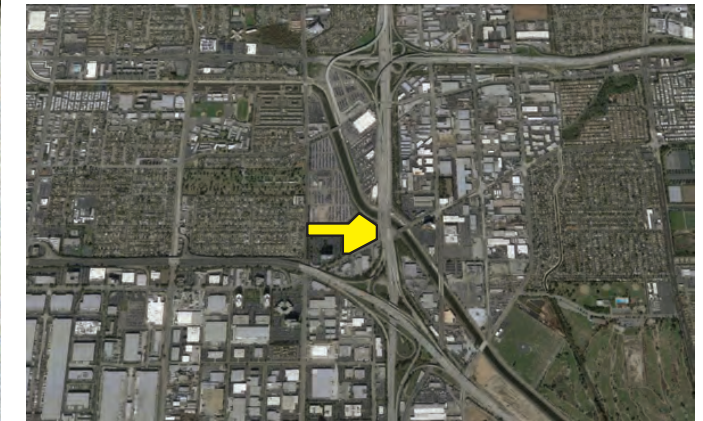

Detail C - Area 11



Detail D - Area 10

Not to scale

This page intentionally left blank

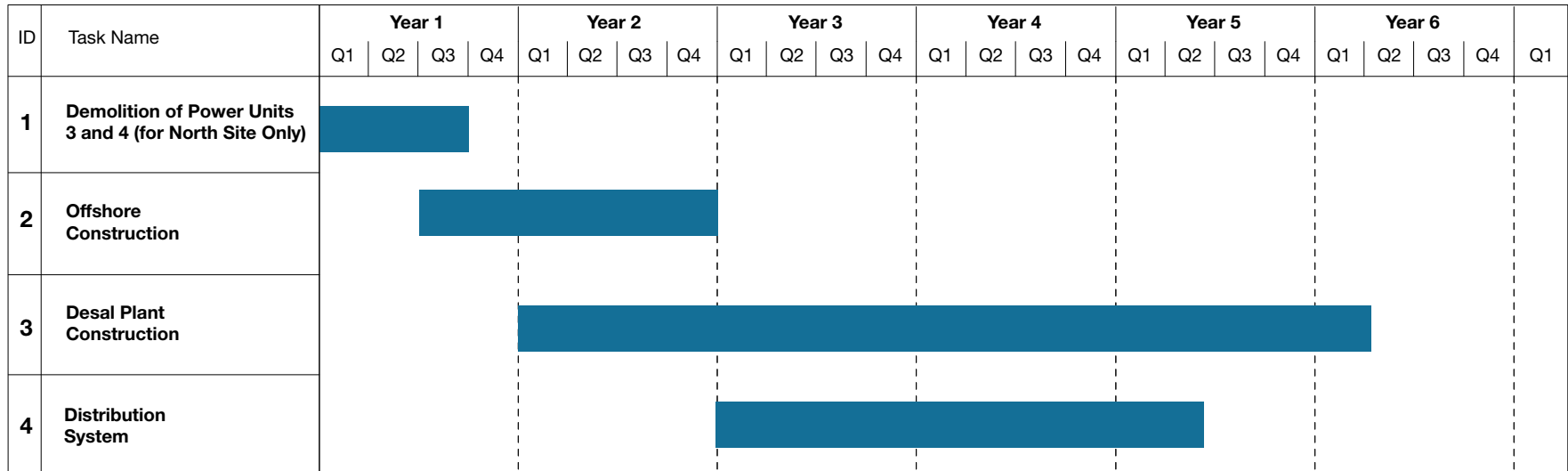

SOURCE: GHD 2017

West Basin Ocean Water Desalination Project

Figure 3-22
Conceptual Local Project Construction Schedule



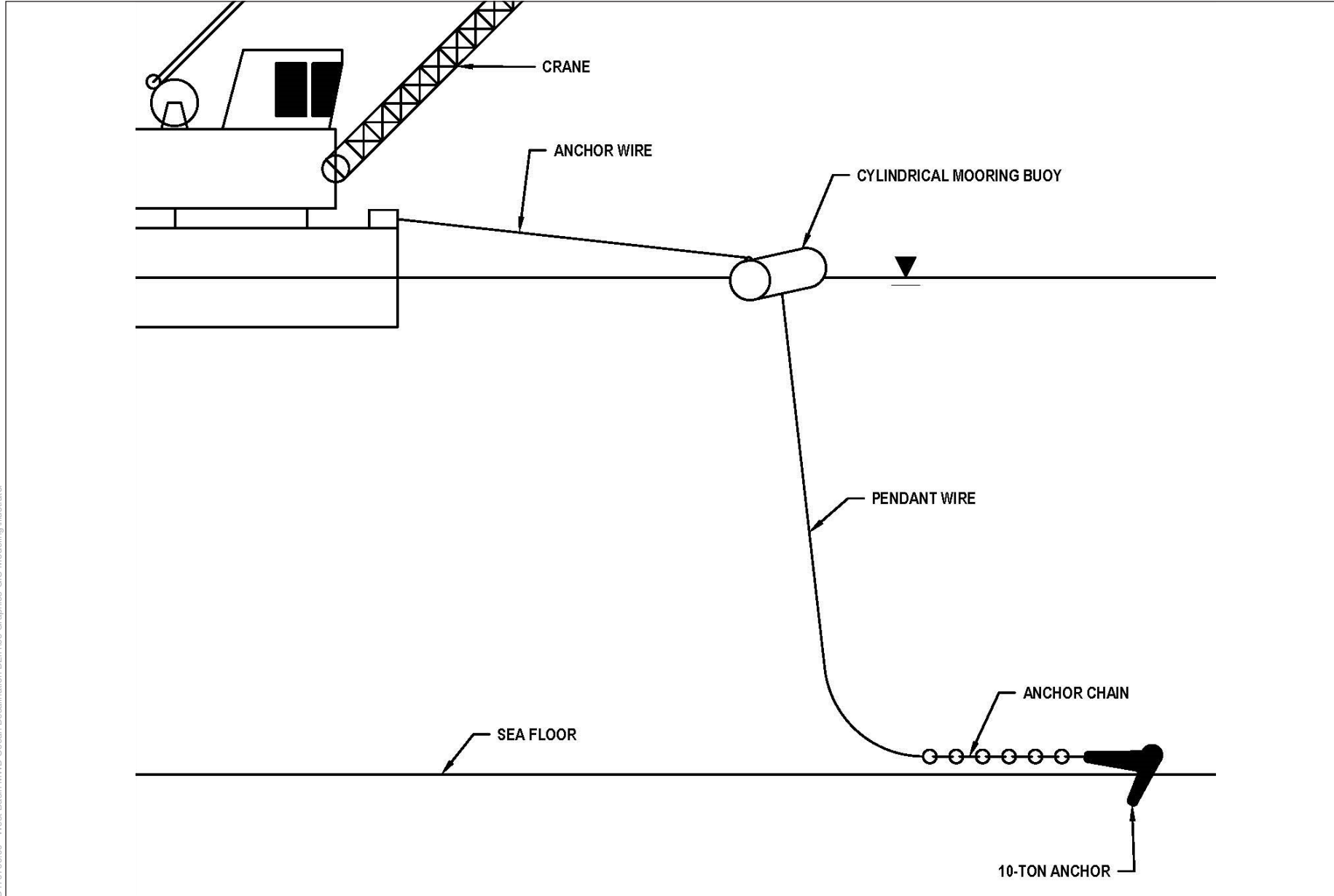

D:\70766.00 - West Basin MWD Ocean Desalination DEIR\05 Graphics-GIS-Modeling\Illustrator

SOURCE: GHD 2017

West Basin Ocean Water Desalination Project

Figure 3-23

Typical Derrick Barge Temporary Mooring Buoy



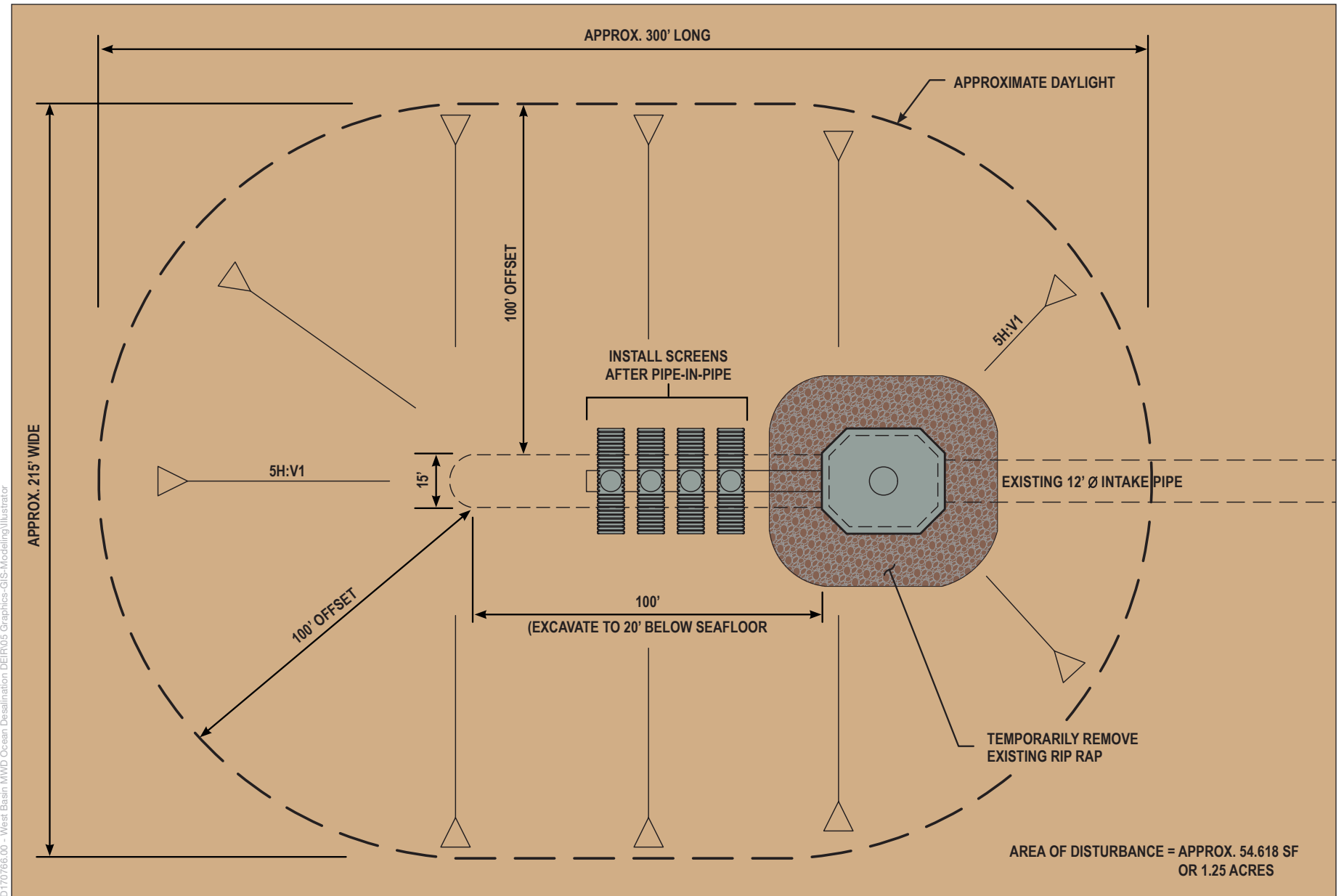

SOURCE: GHD 2017

West Basin Ocean Water Desalination Project

Figure 3-24

Intake Dredge Footprint



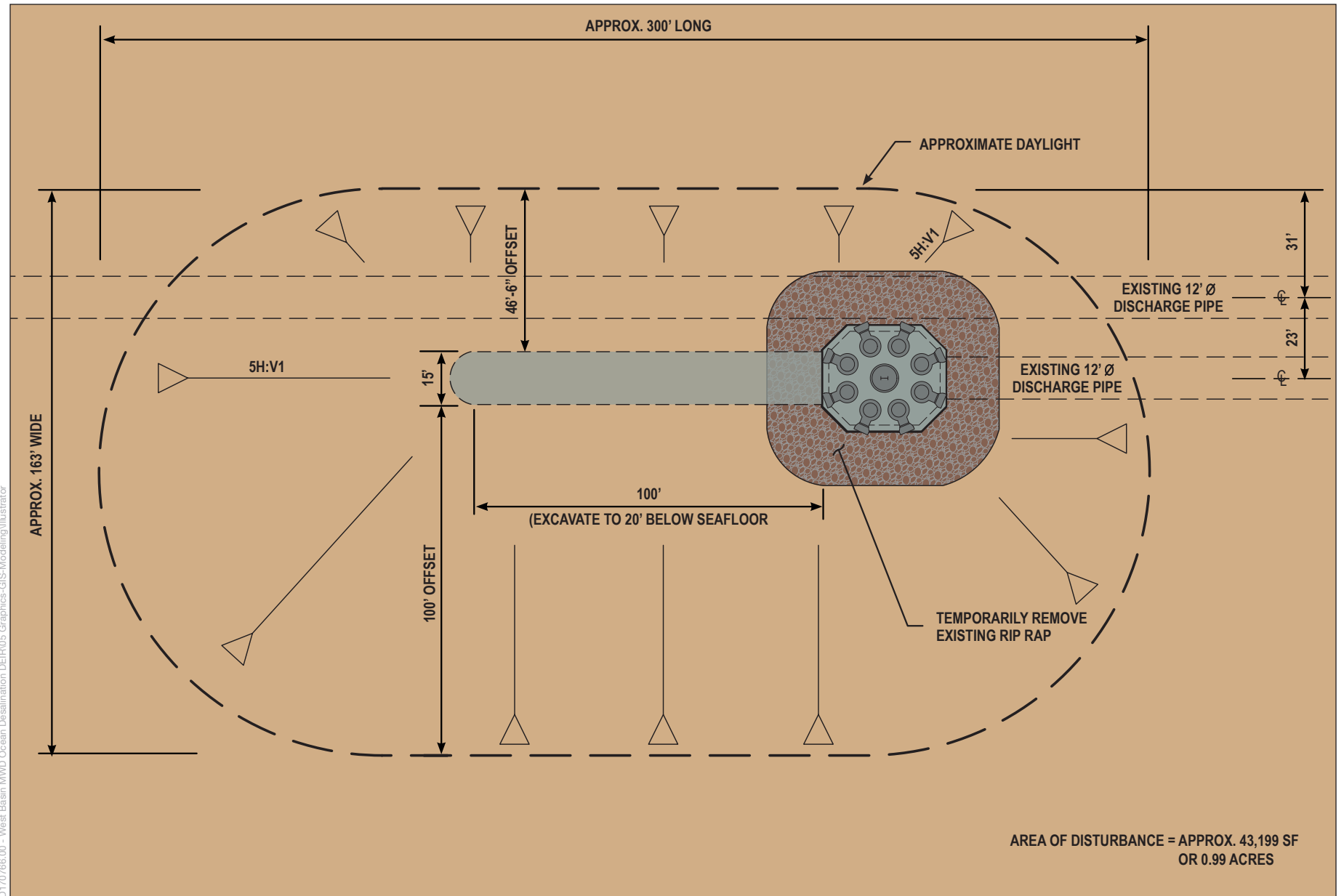

D:\70766.00 - West Basin MWD Ocean Desalination DEIR\05 Graphics-GIS-Modeling\Illustrator

SOURCE: GHD 2017

West Basin Ocean Water Desalination Project

Figure 3-25

Discharge Dredge Footprint

